

Assessor's Parcel Number:

APN# 1319-03-413-016

Recording requested by:

Wells Fargo Bank N.A.
Wells Fargo Home Equity
4455 ArrowsWest Drive
Colorado Springs, CO 80907

When recorded return to:

Wells Fargo Bank N.A.
Wells Fargo Services Co.
Consumer Loan Servicing Center
P.O. Box 31557
Billings, MT 59017-9900

Mail Tax Statements To:

State of Nevada

DEED OF TRUST
(With Future Advance Clause)

6544135636

1. **DATE AND PARTIES.** The date of this Deed of Trust ("Security Instrument") is 19 September 2002 and the parties are as follows:

TRUSTOR ("Grantor"):

JOHN S. HOLMES, AND KAREN A. HOLMES, HUSBAND AND WIFE
AS JOINT TENANTS

whose address is:

1027 BROOKDALE, MERCED, CA 95340-0000

TRUSTEE: American Securities Company of Nevada

8700 NW Walker Rd.
Beaverton, OR 97006

BENEFICIARY ("Lender"):

Wells Fargo Bank N.A.
420 Market Street
San Francisco, CA 92317

0552876

BK0902PG07832

2. **CONVEYANCE.** For good and valuable consideration, the receipt and sufficiency of which is acknowledged, and to secure the Secured Debt (defined below) and Grantor's performance under this Security Instrument, Grantor irrevocably grants, conveys and sells to Trustee, in trust for the benefit of Lender, with power of sale, all of that certain real property located in the County of Douglas, State of Nevada, described as follows:
See attached Exhibit A

This deed of trust is 2nd and subject to a deed of trust securing the note in the amount of \$324,000.00 recording concurrently herewith.

with the address of 2415 GENOA MEADOW CIRCLE

together with all rights, easements, appurtenances, royalties, mineral rights, oil and gas rights, all water and riparian rights, ditches, and water stock and all existing and future improvements, structures, fixtures, and replacements that may now, or at any time in the future, be part of the real estate described above (all referred to as "Property").

3. **MAXIMUM OBLIGATION LIMIT.** The total principal amount secured by this Security Instrument at any one time shall not exceed \$40,500.00. This limitation of amount does not include interest and other fees and charges validly made pursuant to this Security Instrument. Also, this limitation does not apply to advances made under the terms of this Security Instrument to protect Lender's security and to perform any of the covenants contained in this Security Instrument.
4. **SECURED DEBT AND FUTURE ADVANCES.** The term "Secured Debt" is defined as follows:
- A. Debt incurred under the terms of the promissory note, revolving line of credit agreement, contract, guaranty or other evidence of debt dated 9/19/2002 together with all amendments, extensions, modifications or renewals. The maturity date of the Secured Debt is 9/20/2012
 - B. All future advances from Lender to Grantor under such evidence of debt. All future advances are secured as if made on the date of this Security Instrument. Nothing in this Security Instrument shall constitute a commitment to make additional or future loans or advances which exceed the amount shown in Section 3. Any such commitment must be agreed to in a separate writing.
 - C. All sums advanced and expenses incurred by Lender for insuring, preserving, or otherwise protecting the Property and its value and any other sums advanced and expenses incurred by Lender under the terms of this Security Instrument.
5. **PAYMENTS.** Grantor agrees that all payments under the Secured Debt will be paid when due and in accordance with the terms of the Secured Debt and this Security Instrument.
6. **WARRANTY OF TITLE.** Grantor warrants that Grantor is or will be lawfully seized of the estate conveyed by this Security Instrument and has the right to irrevocably grant, convey and sell the Property to Trustee, in trust, with power of sale. Grantor also warrants that the Property is unencumbered, except for encumbrances of record.
7. **PRIOR SECURITY INTERESTS.** With regard to any other mortgage, deed of trust, security agreement or other lien document that created a prior security interest or encumbrance on the Property, Grantor agrees:
- A. To make all payments when due and to perform or comply with all covenants.
 - B. To promptly deliver to Lender any notices that Grantor receives from the holder.
 - C. Not to allow any modification or extension of, nor to request any future advances under any note or agreement secured by the lien document without Lender's prior written consent.

0552876

BK0902PG07833

8. **CLAIMS AGAINST TITLE.** Grantor will pay all taxes, assessments, liens, encumbrances, lease payments, ground rents, utilities, and other charges relating to the Property, or any part thereof or interest therein, whether senior or subordinate hereto, when due. Lender may require Grantor to provide to Lender copies of all notices that such amounts are due and the receipts evidencing Grantor's payment. Grantor will defend title to the Property against any claims that would impair the lien of the Security Instrument. Grantor agrees to assign to Lender, as requested by Lender, any rights, claims or defenses Grantor may have against parties who supply labor or materials to maintain or improve the Property.
9. **DUE ON SALE OR ENCUMBRANCE.** Upon sale, transfer, hypothecation, assignment or encumbrance, whether voluntary, involuntary, or by operation of law, of all or any part of the Property or any interest therein, then at its sole option Lender may, by written notice to Grantor, declare all obligations secured hereby immediately due and payable, except to the extent that such acceleration and in such particular circumstances where exercise of such a right by Lender is prohibited by law.
10. **PROPERTY CONDITION, ALTERATIONS AND INSPECTION.** Grantor will keep the Property in good condition and make all repairs that are reasonably necessary. Grantor shall not commit or allow any waste, impairment, or deterioration of the Property. Grantor will not remove or demolish the Property, or any part thereof. Grantor will keep the Property free of noxious weeds, grasses and public nuisances. Grantor agrees that the nature of the occupancy and use will not substantially change without Lender's prior written consent. Grantor will not permit any change in any license, restrictive covenant or easement without Lender's prior written consent. Grantor will notify Lender of all demands, proceedings, claims, and actions against Grantor, and of any loss or damage to the Property. Lender or Lender's agents may, at Lender's option, enter the Property at any reasonable time for the purpose of inspecting the Property. Lender shall give Grantor notice at the time of or before an inspection specifying a reasonable purpose for the inspection. Any inspection of the Property shall be entirely for Lender's benefit and Grantor will in no way rely on Lender's inspection.
11. **AUTHORITY TO PERFORM.** If Grantor fails to perform any duty or any of the covenants contained in this Security Instrument, Lender may, without notice, perform or cause them to be performed. Grantor appoints Lender as attorney in fact to sign Grantor's name or pay any amount necessary for performance. Lender's right to perform for Grantor shall not create an obligation to perform, and Lender's failure to perform will not preclude Lender from exercising any of Lender's other rights under the law or this Security Instrument. If any construction on the Property is discontinued or not carried on in a reasonable manner, Lender may take all steps necessary to protect Lender's security interest in the Property, including completion of the construction.
12. **ASSIGNMENT OF LEASES AND RENTS.** Grantor irrevocably grants, sells and conveys to Trustee, in trust for the benefit of Lender, as additional security all the right, title and interest in and to any and all existing or future leases, subleases, and any other written or verbal agreements for the use and occupancy of any portion of the Property, including any extensions, renewals, modifications or substitutions of such agreements (all referred to as "Leases") and rents, issues and profits (all referred to as "Rents"). Grantor will promptly provide Lender with true and correct copies of all existing and future Leases. Grantor may collect, receive, enjoy and use the Rents so long as Grantor is not in default under the terms of this Security Instrument. Grantor agrees that this assignment is immediately effective between the parties to this Security Instrument and effective as to third parties on the recording of this Security Instrument. This assignment will remain effective during any period of redemption by the Grantor until the Secured Debt is satisfied. Grantor agrees that Lender is entitled to notify Grantor or Grantor's tenants to make payments of Rents due or to become due directly to Lender after such recording. However, Lender agrees not to notify Grantor's tenants until Grantor defaults and Lender notifies Grantor of the default and demands that Grantor or Grantor's tenants pay all Rents due or to become due directly to Lender. On receiving notice of default, Grantor will endorse and deliver to Lender any payment of Rents in Grantor's possession and will receive any Rents in trust for Lender and will not commingle the Rents with any other funds. Any amounts collected will be applied as provided in this Security Instrument. Grantor warrants that no default exists under the Leases or any applicable landlord/tenant law. Grantor also agrees to maintain and require any tenant to comply with the terms of the Leases and applicable law.

- 13. LEASEHOLDS; CONDOMINIUMS; PLANNED UNIT DEVELOPMENTS.** Grantor agrees to comply with the provisions of any lease if this Security Instrument is on a leasehold. If the property is a unit in a Condominium Project or is part of a Planned Unit Development ("PUD"), Grantor agrees to the following:
- A. Obligations.** Grantor shall perform all of Grantor's obligations under the Constituent Documents. The "Constituent Documents" are the: (i) Declaration or any other document which creates the Condominium Projects or PUD and any homeowners association or equivalent entity ("Owners Association"); (ii) by-laws; (iii) code of regulations; and (iv) other equivalent documents. Grantor shall promptly pay, when due, all dues and assessments imposed pursuant to the Constituent Documents.
 - B. Hazard Insurance.** So long as the Owners Association maintains, with a generally accepted insurance carrier, a "master" or "blanket" policy on the Condominium Project or PUD which is satisfactory to Lender and which provides insurance coverage in the amounts, for the periods, and against the hazards Lender requires, including fire and hazards included within the term "extended coverage," then Grantor's obligation under Section 19 to maintain hazard insurance coverage on the Property is deemed satisfied to the extent that the required coverage is provided by the Owner's Association policy. Grantor shall give Lender prompt notice of any lapse in required hazard insurance coverage. In the event of a distribution of hazard insurance proceeds in lieu of restoration or repair following a loss to Property, whether to the unit or to common elements, any proceeds payable to Grantor are hereby assigned and shall be paid to Lender for application to the sums secured by this Security Instrument, with any excess paid to Grantor.
 - C. Flood Insurance.** Grantor agrees to maintain flood insurance for the life of the Secured Debt which is acceptable, as to form, amount and extent of coverage to Lender.
 - D. Public Liability Insurance.** Grantor shall take such actions as may be reasonable to insure that the Owners Association maintains a public liability insurance policy acceptable in form, amount, and extent of coverage to Lender.
 - E. Condemnation.** The proceeds of any award or claim for damages, direct or consequential, payable to Grantor in connection with any condemnation or other taking of all or any part of the Property, whether of the unit or of the common elements, or for any conveyance in lieu of condemnation, are hereby assigned and shall be paid to Lender. Such proceeds shall be applied by Lender to the sums secured by the Security Instrument as provided in Section 18.
 - F. Lender's Prior Consent.** Grantor shall not, except after notice to Lender and with Lender's prior written consent, either partition or subdivide the Property or consent to: (i) the abandonment or termination of the Condominium Project or PUD, except for abandonment or termination required by law in the case of substantial destruction by fire or other casualty or in the case of a taking by condemnation or eminent domain; (ii) any amendment to any provision of the Constituent Documents if the provision is for the express benefit of Lender; (iii) termination of professional management and assumption of self-management by the Owners Association; or (iv) any action which would have the effect of rendering the public liability insurance coverage maintained by the Owners Association unacceptable to Lender.
 - G. Remedies.** If Grantor does not pay condominium or PUD dues and assessments when due, then Lender may pay them. Any amount disbursed by Lender under this section shall become additional debt of Grantor secured by this Security Instrument. Unless Grantor and Lender agree to other terms of payment, these amounts shall bear interest from the date of disbursement at the Secured Debt rate and shall be payable, with interest, upon notice from Lender to Grantor requesting payment.
- 14. DEFAULT.** Grantor will be in default if any party obligated on the Secured Debt fails to make payment when due. Grantor will be in default if a breach occurs under the terms of this Security Instrument or any other document executed for the purpose of creating, securing or guarantying the Secured Debt. A good faith belief by Lender that Lender at any time is insecure with respect to any person or entity obligated on the Secured Debt or that the prospect of any payment or the value of the Property is impaired shall also constitute an event of default.

0552876

BK0902PG07835

15. REMEDIES ON DEFAULT. In some instances, federal and state law will require Lender to provide Grantor with notice of the right to cure or other notices and may establish time schedules for foreclosure actions. Subject to these limitations, if any, Lender may accelerate the Secured Debt and foreclose this Security Instrument in a manner provided by law if Grantor is in default. At the option of Lender, all or any part of the agreed fees and charges, accrued interest and principal shall become immediately due and payable, after giving notice if required by law, upon the occurrence of a default or anytime thereafter. In addition, Lender shall be entitled to all the remedies provided by law, the terms of the Secured Debt, this Security Instrument and any related documents, including without limitation, the power to sell the Property. If there is a default, Trustee shall, in addition to any other permitted remedy, at the request of the Lender, advertise and sell the Property as a whole or in separate parcels at public auction to the highest bidder for cash and convey absolute title free and clear of all right, title and interest of Grantor at such time and place as Trustee designates. Trustee shall give notice of sale including the time, terms and place of sale and a description of the Property to be sold as required by the applicable law in effect at the time of the proposed sale. Upon sale of the Property and to the extent not prohibited by law, Trustee shall make and deliver a deed to the Property sold which conveys absolute title to the purchaser, and after first paying all fees, charges and costs, shall pay to Lender all moneys advanced for repairs, taxes, insurance, liens, assessments and prior encumbrances and interest thereon, and the principal and interest on the Secured Debt, paying the surplus, if any, to Grantor. Lender may purchase the Property. The recitals in any deed of conveyance shall be prima facie evidence of the facts set forth therein. All remedies are distinct, cumulative and not exclusive, and the Lender is entitled to all remedies provided at law or equity, whether or not expressly set forth. The acceptance by Lender of any sum in payment or partial payment on the Secured Debt after the balance is due or is accelerated or after foreclosure proceedings are filed shall not constitute a waiver of Lender's right to require complete cure of any existing default. By not exercising any remedy on Grantor's default, Lender does not waive Lender's right to later consider the event a default if it continues or happens again.

16. EXPENSES; ADVANCES ON COVENANTS; ATTORNEYS' FEES; COLLECTION COSTS. Except when prohibited by law, Grantor agrees to pay all of Lender's expenses if Grantor breaches any covenant in this Security Instrument. Grantor will also pay on demand any amount incurred by Lender for insuring, inspecting, preserving or otherwise protecting the Property and Lender's security interest. These expenses will bear interest from the date of the payment until paid in full at the highest interest rate in effect as provided in the terms of the Secured Debt. Grantor agrees to pay all costs and expenses incurred by Lender in collecting, enforcing or protecting Lenders' rights and remedies under this Security Instrument. This amount may include, but is not limited to, attorneys' fees, court costs, and other legal expenses. This Security Instrument shall remain in effect until released.

17. ENVIRONMENTAL LAWS AND HAZARDOUS SUBSTANCES. As used in this section, (1) Environmental Law means, without limitation, the Comprehensive Environmental Response, Compensation and Liability Act (CERCLA, 42 U.S.C. 9601 et seq.), and all other federal, state and local laws, regulations, ordinances, court orders, attorney general opinions or interpretive letters concerning the public health, safety, welfare, environment or a hazardous substance; and (2) Hazardous Substance means any toxic, radioactive or hazardous material, waste, pollutant or contaminant which has characteristics which render the substance dangerous or potentially dangerous to the public health, safety, welfare or environment. The term includes, without limitation, any substances defined as "hazardous material," "toxic substances," "hazardous waste" or "hazardous substance" under any Environmental Law.

Grantor represents, warrants and agrees that:

- A. Except as previously disclosed and acknowledged in writing to Lender, no Hazardous Substance is or will be located, stored or released on or in the Property. This restriction does not apply to small quantities of Hazardous Substances that are generally recognized to be appropriate for the normal use and maintenance of the Property.
- B. Except as previously disclosed and acknowledged in writing to Lender, Grantor and every tenant have been, are, and shall remain in full compliance with any applicable Environmental Law.

0552876

BK0902PG07836

- C. Grantor shall immediately notify Lender if a release or threatened release of a Hazardous Substance occurs on, under or about the Property or there is a violation of any Environmental Law concerning the Property. In such an event, Grantor shall take all necessary remedial action in accordance with any Environmental Law.
- D. Grantor shall immediately notify Lender in writing as soon as Grantor has reason to believe there is any pending or threatened investigation, claim, or proceeding relating to the release or threatened release of any Hazardous Substance or the violation of any Environmental Law.
18. **CONDEMNATION.** Grantor will give Lender prompt notice of any pending or threatened action, by private or public entities to purchase or take any or all of the Property through condemnation, eminent domain, or any other means. Grantor authorizes Lender to intervene in Grantor's name in any of the above described actions or claims. Grantor assigns to Lender the proceeds of any award or claim for damages connected with a condemnation or other taking of all or any part of the Property. Such proceeds shall be paid to Lender and applied to the sums secured by this Security Instrument, whether or not then due, with any excess paid to Grantor. This assignment of proceeds is subject to the terms of any prior mortgage, deed of trust, security agreement or other lien document.
19. **INSURANCE.** Grantor shall keep Property insured against loss by fire, flood, theft and other hazards and risks reasonably associated with the Property due to its type and location. This insurance shall be maintained in the amounts and for the periods that Lender requires or is required by applicable law. The insurance carrier providing the insurance shall be chosen by Grantor subject to Lender's approval, which shall not be unreasonably withheld. If Grantor fails to maintain the coverage described above, Lender may, at Lender's option, obtain coverage to protect Lender's rights in the Property according to the terms of this Security Instrument. If Lender determines at any time during the term of the Secured Debt that the Property securing the Secured Debt is not covered by flood insurance or is covered by flood insurance in an amount less than the amount required by law, Lender will notify Grantor that Grantor should obtain flood insurance at Grantor's expense. If Grantor fails to obtain adequate flood insurance which is acceptable to Lender, Lender shall purchase flood insurance on Grantor's behalf. All insurance policies and renewals shall be acceptable to Lender and shall include a standard "mortgage clause" and, where applicable, "loss payee clause." Grantor shall immediately notify Lender of cancellation or termination of the insurance. Lender shall have the right to hold the policies and renewals. If Lender requires, Grantor shall immediately give to Lender all receipts of paid premiums and renewal notices. Upon loss, Grantor shall give immediate notice to the insurance carrier and Lender. Lender may make proof of loss if not made immediately by Grantor. Unless otherwise agreed in writing, all insurance proceeds shall be applied to the restoration or repair of the Property or to the Secured Debt, whether or not then due, at Lender's option. Any application of proceeds to principal shall not extend or postpone the due date of the scheduled payment nor change the amount of any payment. Any excess will be paid to Grantor. If the Property is acquired by Lender, Grantor's right to any insurance policies and proceeds resulting from damage to the Property before the acquisition shall pass to Lender to the extent of the Secured Debt immediately before the acquisition.
20. **ESCROW FOR TAXES AND INSURANCE.** Unless otherwise provided in a separate agreement, Grantor will not be required to pay to Lender funds for taxes and insurance in escrow.
21. **FINANCIAL REPORTS AND ADDITIONAL DOCUMENTS.** Grantor will provide to Lender upon request, any financial statement or information Lender may deem reasonably necessary. Grantor agrees to sign, deliver, and file any additional documents or certifications that Lender may consider necessary to perfect, continue, and preserve Grantor's obligations under this Security Instrument and Lender's lien status on the Property.
22. **JOINT AND INDIVIDUAL LIABILITY; CO-SIGNERS; SUCCESSORS AND ASSIGNS BOUND.** All duties under this Security Instrument are joint and individual. If Grantor signs this Security Instrument but does not sign an evidence of debt, Grantor does so only to transfer, mortgage and convey Grantor's interest in the Property to secure payment of the Secured Debt and Grantor does not agree to be personally liable on the Secured Debt. If this Security Instrument secures a guaranty between Lender and Grantor, Grantor agrees to waive any rights that may prevent Lender from bringing any action or claim against Grantor or any party indebted under the obligation. These rights may include, but are not limited to, any anti-deficiency or one-action laws. Grantor agrees that Lender

0552876

BK0902PG07837

and any party to this Security Instrument may extend, modify or make any change in the terms of this Security Instrument or any evidence of debt without Grantor's consent. Such a change will not release Grantor from the terms of this Security Instrument. The duties and benefits of this Security Instrument shall bind and benefit the successors and assigns of Grantor and Lender.

- 23. APPLICABLE LAW; SEVERABILITY; INTERPRETATION.** This Security Instrument is governed by the laws of the jurisdiction in which the Property is located. This Security Instrument is complete and fully integrated. This Security Instrument may not be amended or modified by oral agreement. Any section in this Security Instrument, attachments, or any agreement related to the Secured Debt that conflicts with applicable law will not be effective, unless that law expressly or impliedly permits the variations by written agreement. If any section of this Security Instrument cannot be enforced according to its terms, that section will be severed and will not affect the enforceability of the remainder of this Security Instrument. Whenever used, the singular shall include the plural and the plural the singular. The captions and headings of the sections of this Security Instrument are for convenience only and are not to be used to interpret or define the terms of this Security Instrument. Time is of the essence in this Security Instrument. In the event any section in this Security Instrument directly conflicts with any section of the revolving line of credit agreement or promissory note referenced in Section 4, the terms and conditions of said revolving credit agreement or promissory note (as applicable), the arbitration agreement, and the agreement to provide flood/property insurance, all of which I agree to by signing this Security Instrument, the terms and conditions of said documents and not the Security Instrument shall control.
- 24. SUCCESSOR TRUSTEE.** Lender, at Lender's option, may from time to time remove Trustee and appoint a successor trustee without any other formality than the designation in writing. The successor trustee, without conveyance of the Property, shall succeed to all the title, power and duties conferred upon Trustee by this Security Instrument and applicable law.
- 25. NOTICE.** Unless otherwise required by law, any notice shall be given by delivering it or by mailing it by first class mail to the appropriate party's address on page 1 of this Security Instrument, or as shown in Lender's records, or to any other address designated in writing. Notice to one Grantor will be deemed to be notice to all Grantors.
- 26. WAIVERS.** In the event Grantor is not also the borrower, customer or obligor (all referred to as "Borrower") under the Secured Debt:
- A. Grantor waives all rights of homestead exemption in the Property.
 - B. Grantor represents and warrants to Lender that this Security Instrument is executed at the request of the Borrower; Grantor will not, without prior written consent of Lender, sell, lease, assign, encumber, hypothecate, transfer or otherwise dispose of all or substantially all of the Property; and Grantor has established adequate means of obtaining from Borrower, on a continuing basis, financial and other information pertaining to the financial condition of Borrower. Grantor agrees to keep adequately informed from such means of any facts, events or circumstances which might in any way affect the risks of Grantor, and Grantor further agrees that Lender has no obligation to disclose to Grantor information or material acquired in the course of Lender's relationship with Borrower.
 - C. Grantor hereby waives any right to require Lender to proceed against any person, including Borrower; proceed against or exhaust any collateral held from Borrower or any other person; pursue any other remedy in Lender's power; or make any presentments, demands for performance or give any notices of nonperformance, protests, notices of protest of dishonor in connections with the Secured Debt and this Security Instrument.
 - D. Grantor also waives any defense arising by reason of any disability or other defense of Borrower or any other defense of Borrower or any other person; the cessation from any cause whatsoever, other than payment in full of the obligations of Borrower under this Security Instrument and Secured Debt; the application by Borrower of the proceeds of the Secured Debt; for purposes

other than the purposes represented by Borrower to Lender or intended or understood by Lender to Grantor; any act or omission by Lender which directly or indirectly results in or aids the discharge of Borrower by operation of law or otherwise, including any impairment or loss of any security resulting from the exercise or election of any remedies by Lender, including, without limitation, election by Lender to exercise any of Lender's rights, now or hereafter obtained, under any power of sale set forth in any security instrument securing repayment of the indebtedness of Borrower and the consequent loss, limitation or impairment of the right to recover any deficiency from Borrower in connection therewith or due to any fair value limitations or determinations in connection with a judicial foreclosure; or any modification of the Secured Debt in any form whatsoever, including, without limitation, the renewal, extension, acceleration or other change in time for payment or any increase in the rate of interest. Until all amounts secured shall have been paid in full, Grantor further waives any right to enforce any remedy which Lender now has or may hereafter have against Borrower or any other person and waives any benefit of, or any right to participate in, any security whatsoever now or hereafter held by Lender.

E. Grantor acknowledges, warrants and agrees that each of the waivers set forth in this section are made with the full knowledge of their significance and consequence and that, under the circumstances, the waivers are reasonable and not contrary to public policy or law. If any of said waivers are determined to be contrary to any applicable law or public policy, such waiver shall be effective only to the extent permitted by law.

27. STATEMENT OF CONDITION. From time to time, as required by law, Lender shall furnish to Grantor or its agent such statements as may be required concerning the condition of the Secured Debt. Lender will charge a fee for such statements as may be permitted by law.

28. RECONVEYANCE. Upon payment of all sums secured by this Security Instrument, Lender shall request Trustee to reconvey the Property and shall surrender this Security Instrument and any note or instrument evidencing the Secured Debt to the Trustee. Trustee shall reconvey, without warranty, the Property or that portion secured by this Security Instrument. To the extent permitted by law, the reconveyance may describe the grantee as "the person or persons legally entitled thereto." Neither Lender nor Trustee shall have any duty to determine the rights of persons claiming to be rightful grantees of any reconveyance. Lender will charge a fee for such reconveyance as may be permitted by law.

SIGNATURES: By signing below, Grantor agrees to the terms and covenants contained in this Security Instrument and in any attachments. Grantor also acknowledges receipt of a copy of this Security Instrument.

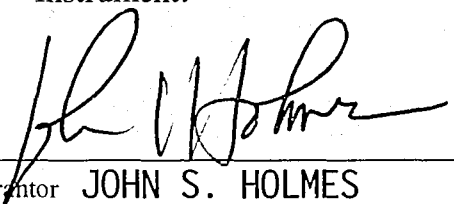
Grantor JOHN S. HOLMES Date

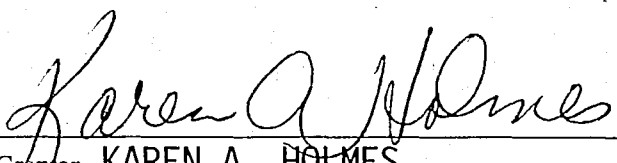
Grantor KAREN A. HOLMES Date

Grantor Date

Grantor Date

Grantor Date

Grantor Date

Grantor Date

Grantor Date

ACKNOWLEDGMENT:

(Individual)

STATE OF NV } ss.

COUNTY OF Douglas } ss.

This instrument was acknowledged before me on _____ by
JOHN S. HOLMES *John S. Holmes*
KAREN A. HOLMES *Karen A. Holmes*

Signature of notarial officer

Title and Rank (Optional)

My commission expires: _____

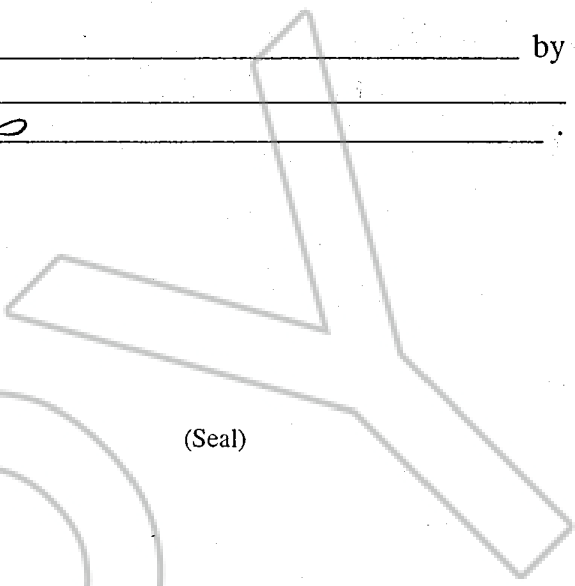

(Seal)

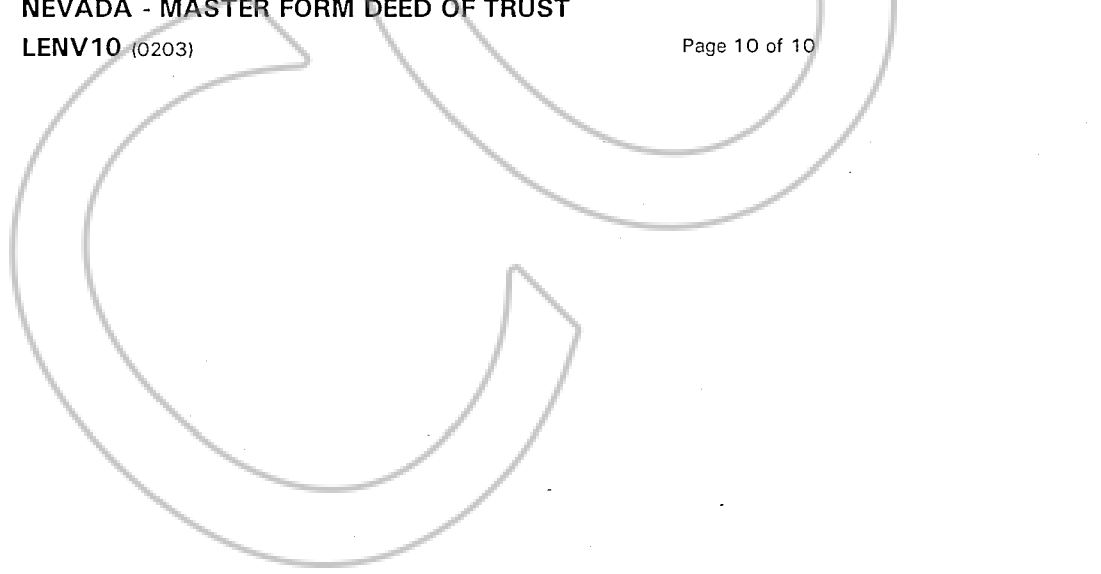

ALL-PURPOSE ACKNOWLEDGEMENT

State of California }
County of Merced } ss.

On September 19, 2002 before me, Marifel J. A. Herland
(DATE) (NOTARY)
personally appeared John S. Holmes and Karen A. Holmes
SIGNER(S)

personally known to me - OR - proved to me on the basis of satisfactory evidence to be the person(s) whose name(s) is/are subscribed to the within instrument and acknowledged to me that he/she/they executed the same in his/her/their authorized capacity(ies), and that by his/her/their signature(s) on the instrument the person(s), or the entity upon behalf of which the person(s) acted, executed the instrument.

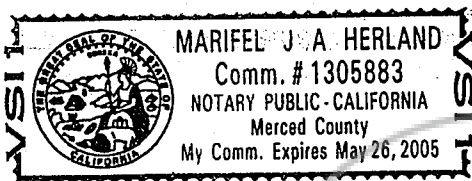

WITNESS my hand and official seal.

Marifel J. A. Herland
NOTARY SIGNATURE

OPTIONAL INFORMATION

The information below is not required by law. However, it could prevent fraudulent attachment of this acknowledgement to an unauthorized document.

CAPACITY CLAIMED BY SIGNER (PRINCIPAL)

- INDIVIDUAL
- CORPORATE OFFICER
- _____ TITLE(S)
- PARTNER(S)
- ATTORNEY-IN-FACT
- TRUSTEE(S)
- GUARDIAN/CONSERVATOR
- OTHER: _____
- _____
- _____

DESCRIPTION OF ATTACHED DOCUMENT

Deed of Trust
TITLE OR TYPE OF DOCUMENT

10
NUMBER OF PAGES

September 19, 2002
DATE OF DOCUMENT

_____ OTHER

SIGNER IS REPRESENTING:
NAME OF PERSON(S) OR ENTITY(IES)

RIGHT THUMBPRINT
OF
SIGNER

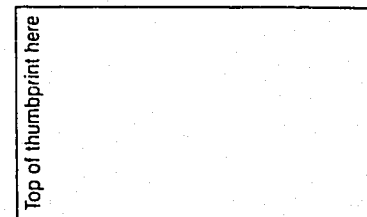

DESCRIPTION

All that certain lot, piece or parcel of land situate in the County of Douglas, State of Nevada, described as follows:

Lot 29, Block A, as set forth on the final map for GENOA LAKES PHASE 4 a Planned Unit Development, recorded May 8, 2000 in Book 0500 of Official Recorded at Page 1613, Douglas County, Nevada as Document No. 491480

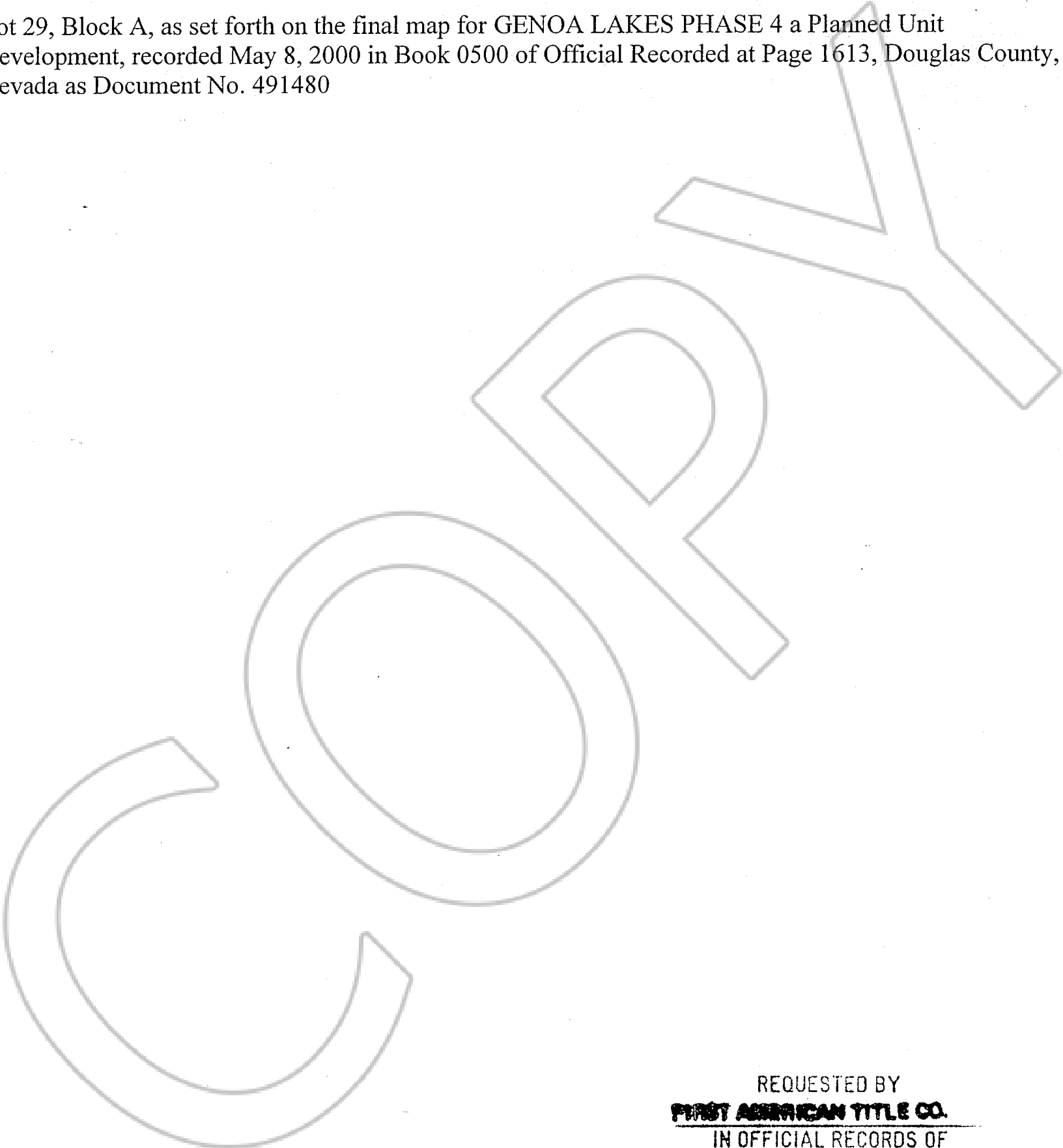

REQUESTED BY
FIRST AMERICAN TITLE CO.
IN OFFICIAL RECORDS OF
DOUGLAS CO. NEVADA

2002 SEP 24 PM 3: 31

LINDA SLATER
RECORDER

\$25⁰⁰ PAID *Kz* DEPUTY

0552876

BK0902PG07843