

Assessor's Parcel Number:  
1420-28-110-045

Return To:  
WFHM FINAL DOCS X9999-01M  
1000 BLUE GENTIAN ROAD  
EAGAN, MN 55121

Douglas County - NV  
Werner Christen - Recorder  
Page: 1 Of 23 Fee: 36.00  
BK-0605 PG- 7029 RPTT: 0.00



Prepared By:  
VISTA MORTGAGE, LLC

12550 SE 93RD AVE, SUITE 400,  
CLACKAMAS, OR 970150000

Recording Requested By:  
VISTA MORTGAGE, LLC

12550 SE 93RD AVE, SUITE 400,  
CLACKAMAS, OR 970150000

[Space Above This Line For Recording Data]

91075SLA

## DEED OF TRUST

### DEFINITIONS

Words used in multiple sections of this document are defined below and other words are defined in Sections 3, 11, 13, 18, 20 and 21. Certain rules regarding the usage of words used in this document are also provided in Section 16.

- (A) "Security Instrument" means this document, which is dated **JUNE 14, 2005** together with all Riders to this document.  
(B) "Borrower" is **STUART B KENNEY, A SINGLE PERSON**

Borrower is the trustor under this Security Instrument.  
(C) "Lender" is **VISTA MORTGAGE, LLC**

Lender is a **LIMITED LIABILITY COMPANY** organized and existing under the laws of **THE STATE OF DELAWARE** 0054851365

NEVADA-Single Family-Fannie Mae/Freddie Mac UNIFORM INSTRUMENT

Form 3029 1/01

VMP -6(NV) (0307)

Page 1 of 15 Initials: *SBK*  
NMFL #3029 (NVCD) Rev 10/12/2004  
VMP Mortgage Solutions (800)521-7291



Lender's address is P.O. BOX 10304, DES MOINES, IA 503060304

Lender is the beneficiary under this Security Instrument.

(D) "Trustee" is UNITED TITLE OF NEVADA  
4100 W. FLAMINGO ROAD, #1000, LAS VEGAS, NV 89103

(E) "Note" means the promissory note signed by Borrower and dated JUNE 14, 2005  
The Note states that Borrower owes Lender THREE HUNDRED FOUR THOUSAND AND 00/100

Dollars  
(U.S. \$ \*\*\*\*304,000.00 ) plus interest. Borrower has promised to pay this debt in regular Periodic Payments and to pay the debt in full not later than JULY 01, 2035

(F) "Property" means the property that is described below under the heading "Transfer of Rights in the Property."

(G) "Loan" means the debt evidenced by the Note, plus interest, any prepayment charges and late charges due under the Note, and all sums due under this Security Instrument, plus interest.

(H) "Riders" means all Riders to this Security Instrument that are executed by Borrower. The following Riders are to be executed by Borrower [check box as applicable]:

<input checked="" type="checkbox"/> Adjustable Rate Rider	<input type="checkbox"/> Condominium Rider	<input type="checkbox"/> Second Home Rider
<input type="checkbox"/> Balloon Rider	<input checked="" type="checkbox"/> Planned Unit Development Rider	<input type="checkbox"/> 1-4 Family Rider
<input type="checkbox"/> VA Rider	<input type="checkbox"/> Biweekly Payment Rider	<input type="checkbox"/> Other(s) [specify]

(I) "Applicable Law" means all controlling applicable federal, state and local statutes, regulations, ordinances and administrative rules and orders (that have the effect of law) as well as all applicable final, non-appealable judicial opinions.

(J) "Community Association Dues, Fees, and Assessments" means all dues, fees, assessments and other charges that are imposed on Borrower or the Property by a condominium association, homeowners association or similar organization.

(K) "Electronic Funds Transfer" means any transfer of funds, other than a transaction originated by check, draft, or similar paper instrument, which is initiated through an electronic terminal, telephonic instrument, computer, or magnetic tape so as to order, instruct, or authorize a financial institution to debit or credit an account. Such term includes, but is not limited to, point-of-sale transfers, automated teller machine transactions, transfers initiated by telephone, wire transfers, and automated clearinghouse transfers.

(L) "Escrow Items" means those items that are described in Section 3.

(M) "Miscellaneous Proceeds" means any compensation, settlement, award of damages, or proceeds paid by any third party (other than insurance proceeds paid under the coverages described in Section 5) for: (i) damage to, or destruction of, the Property; (ii) condemnation or other taking of all or any part of the Property; (iii) conveyance in lieu of condemnation; or (iv) misrepresentations of, or omissions as to, the value and/or condition of the Property.

(N) "Mortgage Insurance" means insurance protecting Lender against the nonpayment of, or default on, the Loan.

(O) "Periodic Payment" means the regularly scheduled amount due for (i) principal and interest under the Note, plus (ii) any amounts under Section 3 of this Security Instrument.

(P) "RESPA" means the Real Estate Settlement Procedures Act (12 U.S.C. Section 2601 et seq.) and its implementing regulation, Regulation X (24 C.F.R. Part 3500), as they might be amended from time to time, or any additional or successor legislation or regulation that governs the same subject matter. As used in this Security Instrument, "RESPA" refers to all requirements and restrictions that are imposed in regard

to a "federally related mortgage loan" even if the Loan does not qualify as a "federally related mortgage loan" under RESPA.

(Q) "Successor in Interest of Borrower" means any party that has taken title to the Property, whether or not that party has assumed Borrower's obligations under the Note and/or this Security Instrument.

**TRANSFER OF RIGHTS IN THE PROPERTY**

This Security Instrument secures to Lender: (i) the repayment of the Loan, and all renewals, extensions and modifications of the Note; and (ii) the performance of Borrower's covenants and agreements under this Security Instrument and the Note. For this purpose, Borrower irrevocably grants and conveys to Trustee, in trust, with power of sale, the following described property located in the COUNTY of DOUGLAS :

[Type of Recording Jurisdiction]

[Name of Recording Jurisdiction]

**SEE ATTACHED LEGAL DESCRIPTION.**

**\*SEE ADJUSTABLE RATE RIDER**

**THIS IS A PURCHASE MONEY SECURITY INSTRUMENT.**

**TAX STATEMENTS SHOULD BE SENT TO: WELLS FARGO HOME MORTGAGE, P.O. BOX 10304, DES MOINES, IA 503060304**

Parcel ID Number: 1420-28-110-045

2988 SAN MATEO DR

MINDEN

("Property Address"):

which currently has the address of

[Street]

[City], Nevada 89423

[Zip Code]

TOGETHER WITH all the improvements now or hereafter erected on the property, and all easements, appurtenances, and fixtures now or hereafter a part of the property. All replacements and additions shall also be covered by this Security Instrument. All of the foregoing is referred to in this Security Instrument as the "Property."

BORROWER COVENANTS that Borrower is lawfully seized of the estate hereby conveyed and has the right to grant and convey the Property and that the Property is unencumbered, except for encumbrances of record. Borrower warrants and will defend generally the title to the Property against all claims and demands, subject to any encumbrances of record.

THIS SECURITY INSTRUMENT combines uniform covenants for national use and non-uniform covenants with limited variations by jurisdiction to constitute a uniform security instrument covering real property.

UNIFORM COVENANTS. Borrower and Lender covenant and agree as follows:

**1. Payment of Principal, Interest, Escrow Items, Prepayment Charges, and Late Charges.**

Borrower shall pay when due the principal of, and interest on, the debt evidenced by the Note and any prepayment charges and late charges due under the Note. Borrower shall also pay funds for Escrow Items

Initials: *SPK*



pursuant to Section 3. Payments due under the Note and this Security Instrument shall be made in U.S. currency. However, if any check or other instrument received by Lender as payment under the Note or this Security Instrument is returned to Lender unpaid, Lender may require that any or all subsequent payments due under the Note and this Security Instrument be made in one or more of the following forms, as selected by Lender: (a) cash; (b) money order; (c) certified check, bank check, treasurer's check or cashier's check, provided any such check is drawn upon an institution whose deposits are insured by a federal agency, instrumentality, or entity; or (d) Electronic Funds Transfer.

Payments are deemed received by Lender when received at the location designated in the Note or at such other location as may be designated by Lender in accordance with the notice provisions in Section 15. Lender may return any payment or partial payment if the payment or partial payments are insufficient to bring the Loan current. Lender may accept any payment or partial payment insufficient to bring the Loan current, without waiver of any rights hereunder or prejudice to its rights to refuse such payment or partial payments in the future, but Lender is not obligated to apply such payments at the time such payments are accepted. If each Periodic Payment is applied as of its scheduled due date, then Lender need not pay interest on unapplied funds. Lender may hold such unapplied funds until Borrower makes payment to bring the Loan current. If Borrower does not do so within a reasonable period of time, Lender shall either apply such funds or return them to Borrower. If not applied earlier, such funds will be applied to the outstanding principal balance under the Note immediately prior to foreclosure. No offset or claim which Borrower might have now or in the future against Lender shall relieve Borrower from making payments due under the Note and this Security Instrument or performing the covenants and agreements secured by this Security Instrument.

**2. Application of Payments or Proceeds.** Except as otherwise described in this Section 2, all payments accepted and applied by Lender shall be applied in the following order of priority: (a) interest due under the Note; (b) principal due under the Note; (c) amounts due under Section 3. Such payments shall be applied to each Periodic Payment in the order in which it became due. Any remaining amounts shall be applied first to late charges, second to any other amounts due under this Security Instrument, and then to reduce the principal balance of the Note.

If Lender receives a payment from Borrower for a delinquent Periodic Payment which includes a sufficient amount to pay any late charge due, the payment may be applied to the delinquent payment and the late charge. If more than one Periodic Payment is outstanding, Lender may apply any payment received from Borrower to the repayment of the Periodic Payments if, and to the extent that, each payment can be paid in full. To the extent that any excess exists after the payment is applied to the full payment of one or more Periodic Payments, such excess may be applied to any late charges due. Voluntary prepayments shall be applied first to any prepayment charges and then as described in the Note.

Any application of payments, insurance proceeds, or Miscellaneous Proceeds to principal due under the Note shall not extend or postpone the due date, or change the amount, of the Periodic Payments.

**3. Funds for Escrow Items.** Borrower shall pay to Lender on the day Periodic Payments are due under the Note, until the Note is paid in full, a sum (the "Funds") to provide for payment of amounts due for: (a) taxes and assessments and other items which can attain priority over this Security Instrument as a lien or encumbrance on the Property; (b) leasehold payments or ground rents on the Property, if any; (c) premiums for any and all insurance required by Lender under Section 5; and (d) Mortgage Insurance premiums, if any, or any sums payable by Borrower to Lender in lieu of the payment of Mortgage Insurance premiums in accordance with the provisions of Section 10. These items are called "Escrow Items." At origination or at any time during the term of the Loan, Lender may require that Community Association Dues, Fees, and Assessments, if any, be escrowed by Borrower, and such dues, fees and assessments shall be an Escrow Item. Borrower shall promptly furnish to Lender all notices of amounts to be paid under this Section. Borrower shall pay Lender the Funds for Escrow Items unless Lender waives Borrower's obligation to pay the Funds for any or all Escrow Items. Lender may waive Borrower's obligation to pay to Lender Funds for any or all Escrow Items at any time. Any such waiver may only be

Initials: *SJK*



in writing. In the event of such waiver, Borrower shall pay directly, when and where payable, the amounts due for any Escrow Items for which payment of Funds has been waived by Lender and, if Lender requires, shall furnish to Lender receipts evidencing such payment within such time period as Lender may require. Borrower's obligation to make such payments and to provide receipts shall for all purposes be deemed to be a covenant and agreement contained in this Security Instrument, as the phrase "covenant and agreement" is used in Section 9. If Borrower is obligated to pay Escrow Items directly, pursuant to a waiver, and Borrower fails to pay the amount due for an Escrow Item, Lender may exercise its rights under Section 9 and pay such amount and Borrower shall then be obligated under Section 9 to repay to Lender any such amount. Lender may revoke the waiver as to any or all Escrow Items at any time by a notice given in accordance with Section 15 and, upon such revocation, Borrower shall pay to Lender all Funds, and in such amounts, that are then required under this Section 3.

Lender may, at any time, collect and hold Funds in an amount (a) sufficient to permit Lender to apply the Funds at the time specified under RESPA, and (b) not to exceed the maximum amount a lender can require under RESPA. Lender shall estimate the amount of Funds due on the basis of current data and reasonable estimates of expenditures of future Escrow Items or otherwise in accordance with Applicable Law.

The Funds shall be held in an institution whose deposits are insured by a federal agency, instrumentality, or entity (including Lender, if Lender is an institution whose deposits are so insured) or in any Federal Home Loan Bank. Lender shall apply the Funds to pay the Escrow Items no later than the time specified under RESPA. Lender shall not charge Borrower for holding and applying the Funds, annually analyzing the escrow account, or verifying the Escrow Items, unless Lender pays Borrower interest on the Funds and Applicable Law permits Lender to make such a charge. Unless an agreement is made in writing or Applicable Law requires interest to be paid on the Funds, Lender shall not be required to pay Borrower any interest or earnings on the Funds. Borrower and Lender can agree in writing, however, that interest shall be paid on the Funds. Lender shall give to Borrower, without charge, an annual accounting of the Funds as required by RESPA.

If there is a surplus of Funds held in escrow, as defined under RESPA, Lender shall account to Borrower for the excess funds in accordance with RESPA. If there is a shortage of Funds held in escrow, as defined under RESPA, Lender shall notify Borrower as required by RESPA, and Borrower shall pay to Lender the amount necessary to make up the shortage in accordance with RESPA, but in no more than 12 monthly payments. If there is a deficiency of Funds held in escrow, as defined under RESPA, Lender shall notify Borrower as required by RESPA, and Borrower shall pay to Lender the amount necessary to make up the deficiency in accordance with RESPA, but in no more than 12 monthly payments.

Upon payment in full of all sums secured by this Security Instrument, Lender shall promptly refund to Borrower any Funds held by Lender.

**4. Charges; Liens.** Borrower shall pay all taxes, assessments, charges, fines, and impositions attributable to the Property which can attain priority over this Security Instrument, leasehold payments or ground rents on the Property, if any, and Community Association Dues, Fees, and Assessments, if any. To the extent that these items are Escrow Items, Borrower shall pay them in the manner provided in Section 3.

Borrower shall promptly discharge any lien which has priority over this Security Instrument unless Borrower: (a) agrees in writing to the payment of the obligation secured by the lien in a manner acceptable to Lender, but only so long as Borrower is performing such agreement; (b) contests the lien in good faith by, or defends against enforcement of the lien in, legal proceedings which in Lender's opinion operate to prevent the enforcement of the lien while those proceedings are pending, but only until such proceedings are concluded; or (c) secures from the holder of the lien an agreement satisfactory to Lender subordinating the lien to this Security Instrument. If Lender determines that any part of the Property is subject to a lien which can attain priority over this Security Instrument, Lender may give Borrower a notice identifying the



lien. Within 10 days of the date on which that notice is given, Borrower shall satisfy the lien or take one or more of the actions set forth above in this Section 4.

Lender may require Borrower to pay a one-time charge for a real estate tax verification and/or reporting service used by Lender in connection with this Loan.

**5. Property Insurance.** Borrower shall keep the improvements now existing or hereafter erected on the Property insured against loss by fire, hazards included within the term "extended coverage," and any other hazards including, but not limited to, earthquakes and floods, for which Lender requires insurance. This insurance shall be maintained in the amounts (including deductible levels) and for the periods that Lender requires. What Lender requires pursuant to the preceding sentences can change during the term of the Loan. The insurance carrier providing the insurance shall be chosen by Borrower subject to Lender's right to disapprove Borrower's choice, which right shall not be exercised unreasonably. Lender may require Borrower to pay, in connection with this Loan, either: (a) a one-time charge for flood zone determination, certification and tracking services; or (b) a one-time charge for flood zone determination and certification services and subsequent charges each time remappings or similar changes occur which reasonably might affect such determination or certification. Borrower shall also be responsible for the payment of any fees imposed by the Federal Emergency Management Agency in connection with the review of any flood zone determination resulting from an objection by Borrower.

If Borrower fails to maintain any of the coverages described above, Lender may obtain insurance coverage, at Lender's option and Borrower's expense. Lender is under no obligation to purchase any particular type or amount of coverage. Therefore, such coverage shall cover Lender, but might or might not protect Borrower, Borrower's equity in the Property, or the contents of the Property, against any risk, hazard or liability and might provide greater or lesser coverage than was previously in effect. Borrower acknowledges that the cost of the insurance coverage so obtained might significantly exceed the cost of insurance that Borrower could have obtained. Any amounts disbursed by Lender under this Section 5 shall become additional debt of Borrower secured by this Security Instrument. These amounts shall bear interest at the Note rate from the date of disbursement and shall be payable, with such interest, upon notice from Lender to Borrower requesting payment.

All insurance policies required by Lender and renewals of such policies shall be subject to Lender's right to disapprove such policies, shall include a standard mortgage clause, and shall name Lender as mortgagee and/or as an additional loss payee. Lender shall have the right to hold the policies and renewal certificates. If Lender requires, Borrower shall promptly give to Lender all receipts of paid premiums and renewal notices. If Borrower obtains any form of insurance coverage, not otherwise required by Lender, for damage to, or destruction of, the Property, such policy shall include a standard mortgage clause and shall name Lender as mortgagee and/or as an additional loss payee.

In the event of loss, Borrower shall give prompt notice to the insurance carrier and Lender. Lender may make proof of loss if not made promptly by Borrower. Unless Lender and Borrower otherwise agree in writing, any insurance proceeds, whether or not the underlying insurance was required by Lender, shall be applied to restoration or repair of the Property, if the restoration or repair is economically feasible and Lender's security is not lessened. During such repair and restoration period, Lender shall have the right to hold such insurance proceeds until Lender has had an opportunity to inspect such Property to ensure the work has been completed to Lender's satisfaction, provided that such inspection shall be undertaken promptly. Lender may disburse proceeds for the repairs and restoration in a single payment or in a series of progress payments as the work is completed. Unless an agreement is made in writing or Applicable Law requires interest to be paid on such insurance proceeds, Lender shall not be required to pay Borrower any interest or earnings on such proceeds. Fees for public adjusters, or other third parties, retained by Borrower shall not be paid out of the insurance proceeds and shall be the sole obligation of Borrower. If the restoration or repair is not economically feasible or Lender's security would be lessened, the insurance proceeds shall be applied to the sums secured by this Security Instrument, whether or not then due, with



the excess, if any, paid to Borrower. Such insurance proceeds shall be applied in the order provided for in Section 2.

If Borrower abandons the Property, Lender may file, negotiate and settle any available insurance claim and related matters. If Borrower does not respond within 30 days to a notice from Lender that the insurance carrier has offered to settle a claim, then Lender may negotiate and settle the claim. The 30-day period will begin when the notice is given. In either event, or if Lender acquires the Property under Section 22 or otherwise, Borrower hereby assigns to Lender (a) Borrower's rights to any insurance proceeds in an amount not to exceed the amounts unpaid under the Note or this Security Instrument, and (b) any other of Borrower's rights (other than the right to any refund of unearned premiums paid by Borrower) under all insurance policies covering the Property, insofar as such rights are applicable to the coverage of the Property. Lender may use the insurance proceeds either to repair or restore the Property or to pay amounts unpaid under the Note or this Security Instrument, whether or not then due.

**6. Occupancy.** Borrower shall occupy, establish, and use the Property as Borrower's principal residence within 60 days after the execution of this Security Instrument and shall continue to occupy the Property as Borrower's principal residence for at least one year after the date of occupancy, unless Lender otherwise agrees in writing, which consent shall not be unreasonably withheld, or unless extenuating circumstances exist which are beyond Borrower's control.

**7. Preservation, Maintenance and Protection of the Property; Inspections.** Borrower shall not destroy, damage or impair the Property, allow the Property to deteriorate or commit waste on the Property. Whether or not Borrower is residing in the Property, Borrower shall maintain the Property in order to prevent the Property from deteriorating or decreasing in value due to its condition. Unless it is determined pursuant to Section 5 that repair or restoration is not economically feasible, Borrower shall promptly repair the Property if damaged to avoid further deterioration or damage. If insurance or condemnation proceeds are paid in connection with damage to, or the taking of, the Property, Borrower shall be responsible for repairing or restoring the Property only if Lender has released proceeds for such purposes. Lender may disburse proceeds for the repairs and restoration in a single payment or in a series of progress payments as the work is completed. If the insurance or condemnation proceeds are not sufficient to repair or restore the Property, Borrower is not relieved of Borrower's obligation for the completion of such repair or restoration.

Lender or its agent may make reasonable entries upon and inspections of the Property. If it has reasonable cause, Lender may inspect the interior of the improvements on the Property. Lender shall give Borrower notice at the time of or prior to such an interior inspection specifying such reasonable cause.

**8. Borrower's Loan Application.** Borrower shall be in default if, during the Loan application process, Borrower or any persons or entities acting at the direction of Borrower or with Borrower's knowledge or consent gave materially false, misleading, or inaccurate information or statements to Lender (or failed to provide Lender with material information) in connection with the Loan. Material representations include, but are not limited to, representations concerning Borrower's occupancy of the Property as Borrower's principal residence.

**9. Protection of Lender's Interest in the Property and Rights Under this Security Instrument.** If (a) Borrower fails to perform the covenants and agreements contained in this Security Instrument, (b) there is a legal proceeding that might significantly affect Lender's interest in the Property and/or rights under this Security Instrument (such as a proceeding in bankruptcy, probate, for condemnation or forfeiture, for enforcement of a lien which may attain priority over this Security Instrument or to enforce laws or regulations), or (c) Borrower has abandoned the Property, then Lender may do and pay for whatever is reasonable or appropriate to protect Lender's interest in the Property and rights under this Security Instrument, including protecting and/or assessing the value of the Property, and securing and/or repairing the Property. Lender's actions can include, but are not limited to: (a) paying any sums secured by a lien which has priority over this Security Instrument; (b) appearing in court; and (c) paying reasonable

attorneys' fees to protect its interest in the Property and/or rights under this Security Instrument, including its secured position in a bankruptcy proceeding. Securing the Property includes, but is not limited to, entering the Property to make repairs, change locks, replace or board up doors and windows, drain water from pipes, eliminate building or other code violations or dangerous conditions, and have utilities turned on or off. Although Lender may take action under this Section 9, Lender does not have to do so and is not under any duty or obligation to do so. It is agreed that Lender incurs no liability for not taking any or all actions authorized under this Section 9.

Any amounts disbursed by Lender under this Section 9 shall become additional debt of Borrower secured by this Security Instrument. These amounts shall bear interest at the Note rate from the date of disbursement and shall be payable, with such interest, upon notice from Lender to Borrower requesting payment.

If this Security Instrument is on a leasehold, Borrower shall comply with all the provisions of the lease. If Borrower acquires fee title to the Property, the leasehold and the fee title shall not merge unless Lender agrees to the merger in writing.

**10. Mortgage Insurance.** If Lender required Mortgage Insurance as a condition of making the Loan, Borrower shall pay the premiums required to maintain the Mortgage Insurance in effect. If, for any reason, the Mortgage Insurance coverage required by Lender ceases to be available from the mortgage insurer that previously provided such insurance and Borrower was required to make separately designated payments toward the premiums for Mortgage Insurance, Borrower shall pay the premiums required to obtain coverage substantially equivalent to the Mortgage Insurance previously in effect, at a cost substantially equivalent to the cost to Borrower of the Mortgage Insurance previously in effect, from an alternate mortgage insurer selected by Lender. If substantially equivalent Mortgage Insurance coverage is not available, Borrower shall continue to pay to Lender the amount of the separately designated payments that were due when the insurance coverage ceased to be in effect. Lender will accept, use and retain these payments as a non-refundable loss reserve in lieu of Mortgage Insurance. Such loss reserve shall be non-refundable, notwithstanding the fact that the Loan is ultimately paid in full, and Lender shall not be required to pay Borrower any interest or earnings on such loss reserve. Lender can no longer require loss reserve payments if Mortgage Insurance coverage (in the amount and for the period that Lender requires) provided by an insurer selected by Lender again becomes available, is obtained, and Lender requires separately designated payments toward the premiums for Mortgage Insurance. If Lender required Mortgage Insurance as a condition of making the Loan and Borrower was required to make separately designated payments toward the premiums for Mortgage Insurance, Borrower shall pay the premiums required to maintain Mortgage Insurance in effect, or to provide a non-refundable loss reserve, until Lender's requirement for Mortgage Insurance ends in accordance with any written agreement between Borrower and Lender providing for such termination or until termination is required by Applicable Law. Nothing in this Section 10 affects Borrower's obligation to pay interest at the rate provided in the Note.

Mortgage Insurance reimburses Lender (or any entity that purchases the Note) for certain losses it may incur if Borrower does not repay the Loan as agreed. Borrower is not a party to the Mortgage Insurance.

Mortgage insurers evaluate their total risk on all such insurance in force from time to time, and may enter into agreements with other parties that share or modify their risk, or reduce losses. These agreements are on terms and conditions that are satisfactory to the mortgage insurer and the other party (or parties) to these agreements. These agreements may require the mortgage insurer to make payments using any source of funds that the mortgage insurer may have available (which may include funds obtained from Mortgage Insurance premiums).

As a result of these agreements, Lender, any purchaser of the Note, another insurer, any reinsurer, any other entity, or any affiliate of any of the foregoing, may receive (directly or indirectly) amounts that derive from (or might be characterized as) a portion of Borrower's payments for Mortgage Insurance, in exchange for sharing or modifying the mortgage insurer's risk, or reducing losses. If such agreement provides that an affiliate of Lender takes a share of the insurer's risk in exchange for a share of the premiums paid to the insurer, the arrangement is often termed "captive reinsurance." Further:

(a) Any such agreements will not affect the amounts that Borrower has agreed to pay for Mortgage Insurance, or any other terms of the Loan. Such agreements will not increase the amount Borrower will owe for Mortgage Insurance, and they will not entitle Borrower to any refund.





(b) Any such agreements will not affect the rights Borrower has - if any - with respect to the Mortgage Insurance under the Homeowners Protection Act of 1998 or any other law. These rights may include the right to receive certain disclosures, to request and obtain cancellation of the Mortgage Insurance, to have the Mortgage Insurance terminated automatically, and/or to receive a refund of any Mortgage Insurance premiums that were unearned at the time of such cancellation or termination.

**11. Assignment of Miscellaneous Proceeds; Forfeiture.** All Miscellaneous Proceeds are hereby assigned to and shall be paid to Lender.

If the Property is damaged, such Miscellaneous Proceeds shall be applied to restoration or repair of the Property, if the restoration or repair is economically feasible and Lender's security is not lessened. During such repair and restoration period, Lender shall have the right to hold such Miscellaneous Proceeds until Lender has had an opportunity to inspect such Property to ensure the work has been completed to Lender's satisfaction, provided that such inspection shall be undertaken promptly. Lender may pay for the repairs and restoration in a single disbursement or in a series of progress payments as the work is completed. Unless an agreement is made in writing or Applicable Law requires interest to be paid on such Miscellaneous Proceeds, Lender shall not be required to pay Borrower any interest or earnings on such Miscellaneous Proceeds. If the restoration or repair is not economically feasible or Lender's security would be lessened, the Miscellaneous Proceeds shall be applied to the sums secured by this Security Instrument, whether or not then due, with the excess, if any, paid to Borrower. Such Miscellaneous Proceeds shall be applied in the order provided for in Section 2.

In the event of a total taking, destruction, or loss in value of the Property, the Miscellaneous Proceeds shall be applied to the sums secured by this Security Instrument, whether or not then due, with the excess, if any, paid to Borrower.

In the event of a partial taking, destruction, or loss in value of the Property in which the fair market value of the Property immediately before the partial taking, destruction, or loss in value is equal to or greater than the amount of the sums secured by this Security Instrument immediately before the partial taking, destruction, or loss in value, unless Borrower and Lender otherwise agree in writing, the sums secured by this Security Instrument shall be reduced by the amount of the Miscellaneous Proceeds multiplied by the following fraction: (a) the total amount of the sums secured immediately before the partial taking, destruction, or loss in value divided by (b) the fair market value of the Property immediately before the partial taking, destruction, or loss in value. Any balance shall be paid to Borrower.

In the event of a partial taking, destruction, or loss in value of the Property in which the fair market value of the Property immediately before the partial taking, destruction, or loss in value is less than the amount of the sums secured immediately before the partial taking, destruction, or loss in value, unless Borrower and Lender otherwise agree in writing, the Miscellaneous Proceeds shall be applied to the sums secured by this Security Instrument whether or not the sums are then due.

If the Property is abandoned by Borrower, or if, after notice by Lender to Borrower that the Opposing Party (as defined in the next sentence) offers to make an award to settle a claim for damages, Borrower fails to respond to Lender within 30 days after the date the notice is given, Lender is authorized to collect and apply the Miscellaneous Proceeds either to restoration or repair of the Property or to the sums secured by this Security Instrument, whether or not then due. "Opposing Party" means the third party that owes Borrower Miscellaneous Proceeds or the party against whom Borrower has a right of action in regard to Miscellaneous Proceeds.

Borrower shall be in default if any action or proceeding, whether civil or criminal, is begun that, in Lender's judgment, could result in forfeiture of the Property or other material impairment of Lender's interest in the Property or rights under this Security Instrument. Borrower can cure such a default and, if acceleration has occurred, reinstate as provided in Section 19, by causing the action or proceeding to be dismissed with a ruling that, in Lender's judgment, precludes forfeiture of the Property or other material impairment of Lender's interest in the Property or rights under this Security Instrument. The proceeds of any award or claim for damages that are attributable to the impairment of Lender's interest in the Property are hereby assigned and shall be paid to Lender.

All Miscellaneous Proceeds that are not applied to restoration or repair of the Property shall be applied in the order provided for in Section 2.



**12. Borrower Not Released; Forbearance By Lender Not a Waiver.** Extension of the time for payment or modification of amortization of the sums secured by this Security Instrument granted by Lender to Borrower or any Successor in Interest of Borrower shall not operate to release the liability of Borrower or any Successors in Interest of Borrower. Lender shall not be required to commence proceedings against any Successor in Interest of Borrower or to refuse to extend time for payment or otherwise modify amortization of the sums secured by this Security Instrument by reason of any demand made by the original Borrower or any Successors in Interest of Borrower. Any forbearance by Lender in exercising any right or remedy including, without limitation, Lender's acceptance of payments from third persons, entities or Successors in Interest of Borrower or in amounts less than the amount then due, shall not be a waiver of or preclude the exercise of any right or remedy.

**13. Joint and Several Liability; Co-signers; Successors and Assigns Bound.** Borrower covenants and agrees that Borrower's obligations and liability shall be joint and several. However, any Borrower who co-signs this Security Instrument but does not execute the Note (a "co-signer"): (a) is co-signing this Security Instrument only to mortgage, grant and convey the co-signer's interest in the Property under the terms of this Security Instrument; (b) is not personally obligated to pay the sums secured by this Security Instrument; and (c) agrees that Lender and any other Borrower can agree to extend, modify, forbear or make any accommodations with regard to the terms of this Security Instrument or the Note without the co-signer's consent.

Subject to the provisions of Section 18, any Successor in Interest of Borrower who assumes Borrower's obligations under this Security Instrument in writing, and is approved by Lender, shall obtain all of Borrower's rights and benefits under this Security Instrument. Borrower shall not be released from Borrower's obligations and liability under this Security Instrument unless Lender agrees to such release in writing. The covenants and agreements of this Security Instrument shall bind (except as provided in Section 20) and benefit the successors and assigns of Lender.

**14. Loan Charges.** Lender may charge Borrower fees for services performed in connection with Borrower's default, for the purpose of protecting Lender's interest in the Property and rights under this Security Instrument, including, but not limited to, attorneys' fees, property inspection and valuation fees. In regard to any other fees, the absence of express authority in this Security Instrument to charge a specific fee to Borrower shall not be construed as a prohibition on the charging of such fee. Lender may not charge fees that are expressly prohibited by this Security Instrument or by Applicable Law.

If the Loan is subject to a law which sets maximum loan charges, and that law is finally interpreted so that the interest or other loan charges collected or to be collected in connection with the Loan exceed the permitted limits, then: (a) any such loan charge shall be reduced by the amount necessary to reduce the charge to the permitted limit; and (b) any sums already collected from Borrower which exceeded permitted limits will be refunded to Borrower. Lender may choose to make this refund by reducing the principal owed under the Note or by making a direct payment to Borrower. If a refund reduces principal, the reduction will be treated as a partial prepayment without any prepayment charge (whether or not a prepayment charge is provided for under the Note). Borrower's acceptance of any such refund made by direct payment to Borrower will constitute a waiver of any right of action Borrower might have arising out of such overcharge.

**15. Notices.** All notices given by Borrower or Lender in connection with this Security Instrument must be in writing. Any notice to Borrower in connection with this Security Instrument shall be deemed to have been given to Borrower when mailed by first class mail or when actually delivered to Borrower's notice address if sent by other means. Notice to any one Borrower shall constitute notice to all Borrowers unless Applicable Law expressly requires otherwise. The notice address shall be the Property Address unless Borrower has designated a substitute notice address by notice to Lender. Borrower shall promptly notify Lender of Borrower's change of address. If Lender specifies a procedure for reporting Borrower's change of address, then Borrower shall only report a change of address through that specified procedure. There may be only one designated notice address under this Security Instrument at any one time. Any notice to Lender shall be given by delivering it or by mailing it by first class mail to Lender's address stated herein unless Lender has designated another address by notice to Borrower. Any notice in connection with this Security Instrument shall not be deemed to have been given to Lender until actually received by Lender. If any notice required by this Security Instrument is also required under Applicable Law, the Applicable Law requirement will satisfy the corresponding requirement under this Security Instrument.

**16. Governing Law; Severability; Rules of Construction.** This Security Instrument shall be governed by federal law and the law of the jurisdiction in which the Property is located. All rights and obligations contained in this Security Instrument are subject to any requirements and limitations of Applicable Law. Applicable Law might explicitly or implicitly allow the parties to agree by contract or it might be silent, but such silence shall not be construed as a prohibition against agreement by contract. In the event that any provision or clause of this Security Instrument or the Note conflicts with Applicable Law, such conflict shall not affect other provisions of this Security Instrument or the Note which can be given effect without the conflicting provision.

As used in this Security Instrument: (a) words of the masculine gender shall mean and include corresponding neuter words or words of the feminine gender; (b) words in the singular shall mean and include the plural and vice versa; and (c) the word "may" gives sole discretion without any obligation to take any action.

**17. Borrower's Copy.** Borrower shall be given one copy of the Note and of this Security Instrument.

**18. Transfer of the Property or a Beneficial Interest in Borrower.** As used in this Section 18, "Interest in the Property" means any legal or beneficial interest in the Property, including, but not limited to, those beneficial interests transferred in a bond for deed, contract for deed, installment sales contract or escrow agreement, the intent of which is the transfer of title by Borrower at a future date to a purchaser.

If all or any part of the Property or any Interest in the Property is sold or transferred (or if Borrower is not a natural person and a beneficial interest in Borrower is sold or transferred) without Lender's prior written consent, Lender may require immediate payment in full of all sums secured by this Security Instrument. However, this option shall not be exercised by Lender if such exercise is prohibited by Applicable Law.

If Lender exercises this option, Lender shall give Borrower notice of acceleration. The notice shall provide a period of not less than 30 days from the date the notice is given in accordance with Section 15 within which Borrower must pay all sums secured by this Security Instrument. If Borrower fails to pay these sums prior to the expiration of this period, Lender may invoke any remedies permitted by this Security Instrument without further notice or demand on Borrower.

**19. Borrower's Right to Reinstate After Acceleration.** If Borrower meets certain conditions, Borrower shall have the right to have enforcement of this Security Instrument discontinued at any time prior to the earliest of: (a) five days before sale of the Property pursuant to any power of sale contained in this Security Instrument; (b) such other period as Applicable Law might specify for the termination of Borrower's right to reinstate; or (c) entry of a judgment enforcing this Security Instrument. Those conditions are that Borrower: (a) pays Lender all sums which then would be due under this Security Instrument and the Note as if no acceleration had occurred; (b) cures any default of any other covenants or agreements; (c) pays all expenses incurred in enforcing this Security Instrument, including, but not limited to, reasonable attorneys' fees, property inspection and valuation fees, and other fees incurred for the purpose of protecting Lender's interest in the Property and rights under this Security Instrument; and (d) takes such action as Lender may reasonably require to assure that Lender's interest in the Property and rights under this Security Instrument, and Borrower's obligation to pay the sums secured by this Security Instrument, shall continue unchanged. Lender may require that Borrower pay such reinstatement sums and expenses in one or more of the following forms, as selected by Lender: (a) cash; (b) money order; (c) certified check, bank check, treasurer's check or cashier's check, provided any such check is drawn upon an institution whose deposits are insured by a federal agency, instrumentality or entity; or (d) Electronic Funds Transfer. Upon reinstatement by Borrower, this Security Instrument and obligations secured hereby shall remain fully effective as if no acceleration had occurred. However, this right to reinstate shall not apply in the case of acceleration under Section 18.

**20. Sale of Note; Change of Loan Servicer; Notice of Grievance.** The Note or a partial interest in the Note (together with this Security Instrument) can be sold one or more times without prior notice to Borrower. A sale might result in a change in the entity (known as the "Loan Servicer") that collects Periodic Payments due under the Note and this Security Instrument and performs other mortgage loan servicing obligations under the Note, this Security Instrument, and Applicable Law. There also might be

one or more changes of the Loan Servicer unrelated to a sale of the Note. If there is a change of the Loan Servicer, Borrower will be given written notice of the change which will state the name and address of the new Loan Servicer, the address to which payments should be made and any other information RESPA requires in connection with a notice of transfer of servicing. If the Note is sold and thereafter the Loan is serviced by a Loan Servicer other than the purchaser of the Note, the mortgage loan servicing obligations to Borrower will remain with the Loan Servicer or be transferred to a successor Loan Servicer and are not assumed by the Note purchaser unless otherwise provided by the Note purchaser.

Neither Borrower nor Lender may commence, join, or be joined to any judicial action (as either an individual litigant or the member of a class) that arises from the other party's actions pursuant to this Security Instrument or that alleges that the other party has breached any provision of, or any duty owed by reason of, this Security Instrument, until such Borrower or Lender has notified the other party (with such notice given in compliance with the requirements of Section 15) of such alleged breach and afforded the other party hereto a reasonable period after the giving of such notice to take corrective action. If Applicable Law provides a time period which must elapse before certain action can be taken, that time period will be deemed to be reasonable for purposes of this paragraph. The notice of acceleration and opportunity to cure given to Borrower pursuant to Section 22 and the notice of acceleration given to Borrower pursuant to Section 18 shall be deemed to satisfy the notice and opportunity to take corrective action provisions of this Section 20.

**21. Hazardous Substances.** As used in this Section 21: (a) "Hazardous Substances" are those substances defined as toxic or hazardous substances, pollutants, or wastes by Environmental Law and the following substances: gasoline, kerosene, other flammable or toxic petroleum products, toxic pesticides and herbicides, volatile solvents, materials containing asbestos or formaldehyde, and radioactive materials; (b) "Environmental Law" means federal laws and laws of the jurisdiction where the Property is located that relate to health, safety or environmental protection; (c) "Environmental Cleanup" includes any response action, remedial action, or removal action, as defined in Environmental Law; and (d) an "Environmental Condition" means a condition that can cause, contribute to, or otherwise trigger an Environmental Cleanup.

Borrower shall not cause or permit the presence, use, disposal, storage, or release of any Hazardous Substances, or threaten to release any Hazardous Substances, on or in the Property. Borrower shall not do, nor allow anyone else to do, anything affecting the Property (a) that is in violation of any Environmental Law, (b) which creates an Environmental Condition, or (c) which, due to the presence, use, or release of a Hazardous Substance, creates a condition that adversely affects the value of the Property. The preceding two sentences shall not apply to the presence, use, or storage on the Property of small quantities of Hazardous Substances that are generally recognized to be appropriate to normal residential uses and to maintenance of the Property (including, but not limited to, hazardous substances in consumer products).

Borrower shall promptly give Lender written notice of (a) any investigation, claim, demand, lawsuit or other action by any governmental or regulatory agency or private party involving the Property and any Hazardous Substance or Environmental Law of which Borrower has actual knowledge, (b) any Environmental Condition, including but not limited to, any spilling, leaking, discharge, release or threat of release of any Hazardous Substance, and (c) any condition caused by the presence, use or release of a Hazardous Substance which adversely affects the value of the Property. If Borrower learns, or is notified by any governmental or regulatory authority, or any private party, that any removal or other remediation of any Hazardous Substance affecting the Property is necessary, Borrower shall promptly take all necessary remedial actions in accordance with Environmental Law. Nothing herein shall create any obligation on Lender for an Environmental Cleanup.



NON-UNIFORM COVENANTS. Borrower and Lender further covenant and agree as follows:

**22. Acceleration; Remedies.** Lender shall give notice to Borrower prior to acceleration following Borrower's breach of any covenant or agreement in this Security Instrument (but not prior to acceleration under Section 18 unless Applicable Law provides otherwise). The notice shall specify: (a) the default; (b) the action required to cure the default; (c) a date, not less than 30 days from the date the notice is given to Borrower, by which the default must be cured; and (d) that failure to cure the default on or before the date specified in the notice may result in acceleration of the sums secured by this Security Instrument and sale of the Property. The notice shall further inform Borrower of the right to reinstate after acceleration and the right to bring a court action to assert the non-existence of a default or any other defense of Borrower to acceleration and sale. If the default is not cured on or before the date specified in the notice, Lender at its option, and without further demand, may invoke the power of sale, including the right to accelerate full payment of the Note, and any other remedies permitted by Applicable Law. Lender shall be entitled to collect all expenses incurred in pursuing the remedies provided in this Section 22, including, but not limited to, reasonable attorneys' fees and costs of title evidence.

If Lender invokes the power of sale, Lender shall execute or cause Trustee to execute written notice of the occurrence of an event of default and of Lender's election to cause the Property to be sold, and shall cause such notice to be recorded in each county in which any part of the Property is located. Lender shall mail copies of the notice as prescribed by Applicable Law to Borrower and to the persons prescribed by Applicable Law. Trustee shall give public notice of sale to the persons and in the manner prescribed by Applicable Law. After the time required by Applicable Law, Trustee, without demand on Borrower, shall sell the Property at public auction to the highest bidder at the time and place and under the terms designated in the notice of sale in one or more parcels and in any order Trustee determines. Trustee may postpone sale of all or any parcel of the Property by public announcement at the time and place of any previously scheduled sale. Lender or its designee may purchase the Property at any sale.

Trustee shall deliver to the purchaser Trustee's deed conveying the Property without any covenant or warranty, expressed or implied. The recitals in the Trustee's deed shall be prima facie evidence of the truth of the statements made therein. Trustee shall apply the proceeds of the sale in the following order: (a) to all expenses of the sale, including, but not limited to, reasonable Trustee's and attorneys' fees; (b) to all sums secured by this Security Instrument; and (c) any excess to the person or persons legally entitled to it.

**23. Reconveyance.** Upon payment of all sums secured by this Security Instrument, Lender shall request Trustee to reconvey the Property and shall surrender this Security Instrument and all notes evidencing debt secured by this Security Instrument to Trustee. Trustee shall reconvey the Property without warranty to the person or persons legally entitled to it. Such person or persons shall pay any recordation costs. Lender may charge such person or persons a fee for reconveying the Property, but only if the fee is paid to a third party (such as the Trustee) for services rendered and the charging of the fee is permitted under Applicable Law.

**24. Substitute Trustee.** Lender at its option, may from time to time remove Trustee and appoint a successor trustee to any Trustee appointed hereunder. Without conveyance of the Property, the successor trustee shall succeed to all the title, power and duties conferred upon Trustee herein and by Applicable Law.

**25. Assumption Fee.** If there is an assumption of this loan, Lender may charge an assumption fee of U.S. \$ 900.00



BY SIGNING BELOW, Borrower accepts and agrees to the terms and covenants contained in this Security Instrument and in any Rider executed by Borrower and recorded with it.

Witnesses:

\_\_\_\_\_

  
\_\_\_\_\_  
STUART B KENNEY (Seal)  
-Borrower

\_\_\_\_\_

\_\_\_\_\_  
(Seal)  
-Borrower

\_\_\_\_\_  
(Seal)  
-Borrower

\_\_\_\_\_  
(Seal)  
-Borrower

\_\_\_\_\_  
(Seal)  
-Borrower

\_\_\_\_\_  
(Seal)  
-Borrower

\_\_\_\_\_  
(Seal)  
-Borrower

\_\_\_\_\_  
(Seal)  
-Borrower



STATE OF NEVADA  
COUNTY OF *Carson City*

This instrument was acknowledged before me on *6/14/05*  
STUART B KENNEY

by

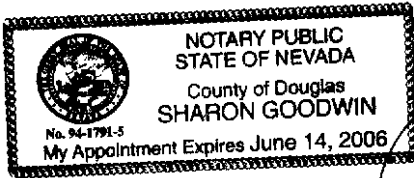

Mail Tax Statements To:  
WELLS FARGO HOME MORTGAGE, P.O. BOX 10304, DES MOINES, IA 503060304



**Legal Description**

All that real property situate in the County of Douglas, State of Nevada, described as follows:

Lot 108, in Block D, as set forth on FINAL MAP OF SARATOGA SPRINGS ESTATES UNIT NO. 3, a Planned Unit Development, filed for record in the office of the County Recorder of Douglas County, State of Nevada, on June 23, 1998, in Book 698, Page 5063, as Document No. 442616, Official Records of Douglas County, Nevada.

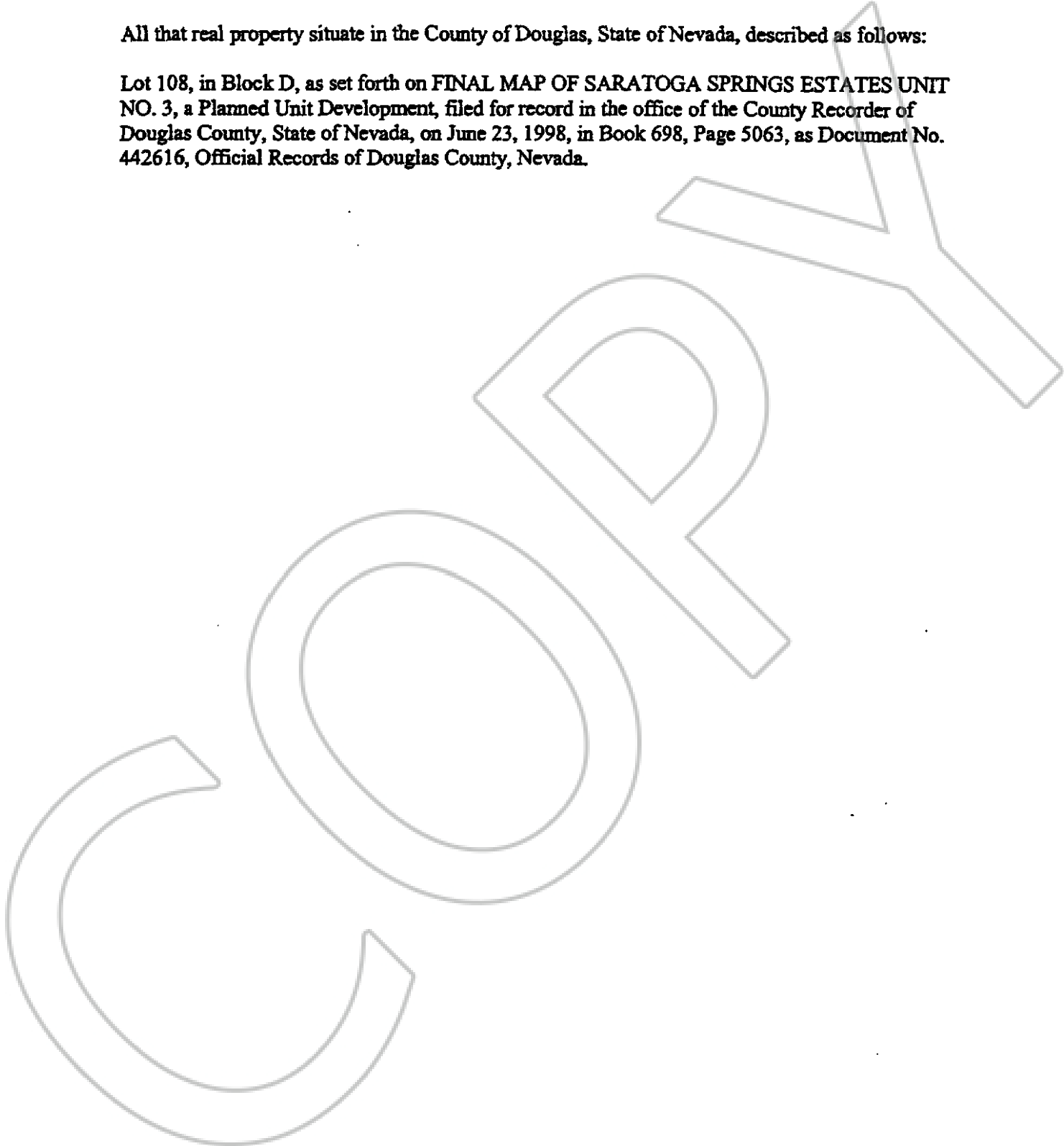



# ADJUSTABLE RATE RIDER

(1-Year Treasury Index - Rate Caps)

(Assumable after Initial Period)

THIS ADJUSTABLE RATE RIDER is made this 14 day of JUNE 2005, and is incorporated into and shall be deemed to amend and supplement the Mortgage, Deed of Trust, or Security Deed (the "Security Instrument") of the same date given by the undersigned (the "Borrower") to secure the Borrower's Adjustable Rate Note (the "Note") to VISTA MORTGAGE, LLC

(the "Lender") of the same date and covering the property described in the Security Instrument and located at:  
2988 SAN MATEO DR, MINDEN, NV 89423

[Property Address]

THE NOTE CONTAINS PROVISIONS ALLOWING FOR CHANGES IN THE INTEREST RATE AND THE MONTHLY PAYMENT. THE NOTE LIMITS THE AMOUNT THE BORROWER'S INTEREST RATE CAN CHANGE AT ANY ONE TIME AND THE MAXIMUM RATE THE BORROWER MUST PAY.

**ADDITIONAL COVENANTS.** In addition to the covenants and agreements made in the Security Instrument, Borrower and Lender further covenant and agree as follows:

**A. INTEREST RATE AND MONTHLY PAYMENT CHANGES**

The Note provides for an initial interest rate of 5.500 %. The Note provides for changes in the interest rate and the monthly payments as follows:

**4. INTEREST RATE AND MONTHLY PAYMENT CHANGES**

**(A) Change Dates**

The interest rate I will pay may change on the first day of JULY, 2010, and may change on that day every 12th month thereafter. Each date on which my interest rate could change is called a "Change Date."

**(B) The Index**

Beginning with the first Change Date, my interest rate will be based on an Index. The "Index" is the weekly average yield on United States Treasury securities adjusted to a constant maturity of one year, as made available by the Federal Reserve Board. The most recent Index figure available as of the date 45 days before each Change Date is called the "Current Index."

If the Index is no longer available, the Note Holder will choose a new index which is based upon comparable information. The Note Holder will give me notice of this choice.

0054851365

MULTISTATE ADJUSTABLE RATE RIDER - 1-Year Treasury Index (Assumable after Initial Period) - Single Family - Freddie Mac UNIFORM INSTRUMENT Form 5110 3/04

VMP-834R (0405).01

Page 1 of 4

Initials: *SAK*

VMP Mortgage Solutions, Inc. (800)521-7291

NMFL #8361 (FM5R) Rev 12/8/2004



BK- 0605  
PG- 7045  
0647003 Page: 17 Of 23 06/16/2005

**(C) Calculation of Changes**

Before each Change Date, the Note Holder will calculate my new interest rate by adding **TWO AND THREE-QUARTERS** percentage point(s) ( **2.75 %**) to the Current Index. The Note Holder will then round the result of this addition to the nearest one-eighth of one percentage point (0.125%). Subject to the limits stated in Section 4(D) below, this rounded amount will be my new interest rate until the next Change Date.

The Note Holder will then determine the amount of the monthly payment that would be sufficient to repay the unpaid principal that I am expected to owe at the Change Date in full on the maturity date at my new interest rate in substantially equal payments. The result of this calculation will be the new amount of my monthly payment.

**(D) Limits on Interest Rate Changes**

The interest rate I am required to pay at the first Change Date will not be greater than **10.500 %** or less than **2.750 %**. Thereafter, my interest rate will never be increased or decreased on any single Change Date by more than

**TWO** percentage point(s) ( **2.000 %**) from the rate of interest I have been paying for the preceding 12 months. My interest rate will never be greater than **10.500 %**.

**(E) Effective Date of Changes**

My new interest rate will become effective on each Change Date. I will pay the amount of my new monthly payment beginning on the first monthly payment date after the Change Date until the amount of my monthly payment changes again.

**(F) Notice of Changes**

The Note Holder will deliver or mail to me a notice of any changes in my interest rate and the amount of my monthly payment before the effective date of any change. The notice will include information required by law to be given to me and also the title and telephone number of a person who will answer any question I may have regarding the notice.

**B. TRANSFER OF THE PROPERTY OR A BENEFICIAL INTEREST IN BORROWER**

**1. UNTIL BORROWER'S INITIAL INTEREST RATE CHANGES UNDER THE TERMS STATED IN SECTION A ABOVE, UNIFORM COVENANT 18 OF THE SECURITY INSTRUMENT SHALL BE IN EFFECT AS FOLLOWS:**

**Transfer of the Property or a Beneficial Interest in Borrower.** As used in this Section 18, "Interest in the Property" means any legal or beneficial interest in the Property, including, but not limited to, those beneficial interests transferred in a bond for deed, contract for deed, installment sales contract or escrow agreement, the intent of which is the transfer of title by Borrower at a future date to a purchaser.

If all or any part of the Property or any Interest in the Property is sold or transferred (or if Borrower is not a natural person and a beneficial interest in Borrower is sold or transferred) without Lender's prior written consent, Lender may require immediate payment in full of all sums secured by this Security Instrument. However, this option shall not be exercised by Lender if such exercise is prohibited by Applicable Law.

Initials: *SK*



If Lender exercises this option, Lender shall give Borrower notice of acceleration. The notice shall provide a period of not less than 30 days from the date the notice is given in accordance with Section 15 within which Borrower must pay all sums secured by this Security Instrument. If Borrower fails to pay these sums prior to the expiration of this period, Lender may invoke any remedies permitted by this Security Instrument without further notice or demand on Borrower.

**2. AFTER BORROWER'S INITIAL INTEREST RATE CHANGES UNDER THE TERMS STATED IN SECTION A ABOVE, UNIFORM COVENANT 18 OF THE SECURITY INSTRUMENT DESCRIBED IN SECTION B1 ABOVE SHALL THEN CEASE TO BE IN EFFECT, AND THE PROVISIONS OF UNIFORM COVENANT 18 OF THE SECURITY INSTRUMENT SHALL BE AMENDED TO READ AS FOLLOWS:**

**Transfer of the Property or a Beneficial Interest in Borrower.** As used in this Section 18, "Interest in the Property" means any legal or beneficial interest in the Property, including, but not limited to, those beneficial interests transferred in a bond for deed, contract for deed, installment sales contract or escrow agreement, the intent of which is the transfer of title by Borrower at a future date to a purchaser.

If all or any part of the Property or any Interest in the Property is sold or transferred (or if Borrower is not a natural person and a beneficial interest in Borrower is sold or transferred) without Lender's prior written consent, Lender may require immediate payment in full of all sums secured by this Security Instrument. However, this option shall not be exercised by Lender if such exercise is prohibited by Applicable Law. Lender also shall not exercise this option if: (a) Borrower causes to be submitted to Lender information required by Lender to evaluate the intended transferee as if a new loan were being made to the transferee; and (b) Lender reasonably determines that Lender's security will not be impaired by the loan assumption and that the risk of a breach of any covenant or agreement in this Security Instrument is acceptable to Lender.

To the extent permitted by Applicable Law, Lender may charge a reasonable fee as a condition to Lender's consent to the loan assumption. Lender may also require the transferee to sign an assumption agreement that is acceptable to Lender and that obligates the transferee to keep all the promises and agreements made in the Note and in this Security Instrument. Borrower will continue to be obligated under the Note and this Security Instrument unless Lender releases Borrower in writing.

If Lender exercises the option to require immediate payment in full, Lender shall give Borrower notice of acceleration. The notice shall provide a period of not less than 30 days from the date the notice is given in accordance with Section 15 within which Borrower must pay all sums secured by this Security Instrument. If Borrower fails to pay these sums prior to the expiration of this period, Lender may invoke any remedies permitted by this Security Instrument without further notice or demand on Borrower.

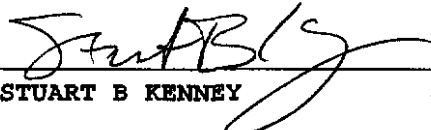

BY SIGNING BELOW, Borrower accepts and agrees to the terms and covenants contained in this Adjustable Rate Rider.

  
\_\_\_\_\_  
STUART B KENNEY (Seal)  
-Borrower

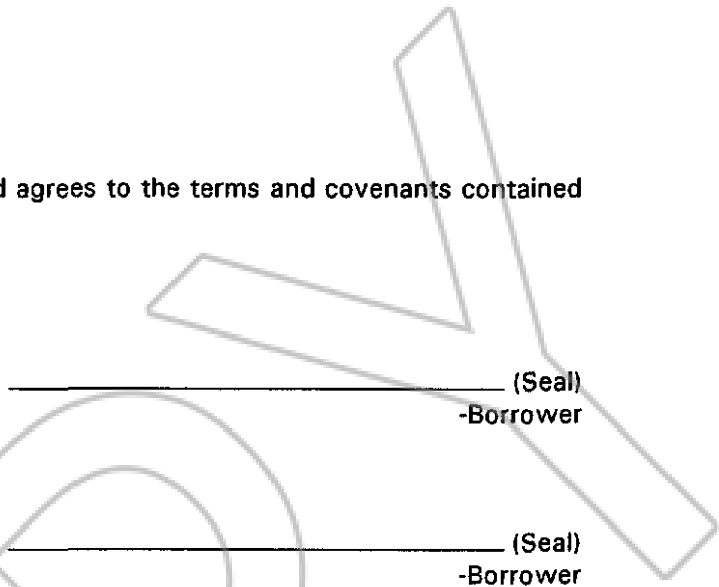

\_\_\_\_\_  
(Seal)  
-Borrower

\_\_\_\_\_  
(Seal)  
-Borrower

\_\_\_\_\_  
(Seal)  
-Borrower

\_\_\_\_\_  
(Seal)  
-Borrower

\_\_\_\_\_  
(Seal)  
-Borrower

\_\_\_\_\_  
(Seal)  
-Borrower

VMP-834R (0405).01

Page 4 of 4

Form 5110 3/04



# PLANNED UNIT DEVELOPMENT RIDER

THIS PLANNED UNIT DEVELOPMENT RIDER is made this **14TH** day of **JUNE, 2005**, and is incorporated into and shall be deemed to amend and supplement the Mortgage, Deed of Trust, or Security Deed (the "Security Instrument") of the same date, given by the undersigned (the "Borrower") to secure Borrower's Note to **VISTA MORTGAGE, LLC**

(the "Lender") of the same date and covering the Property described in the Security Instrument and located at: **2988 SAN MATEO DR, MINDEN, NV 89423**

[Property Address]

The Property includes, but is not limited to, a parcel of land improved with a dwelling, together with other such parcels and certain common areas and facilities, as described in **COVENANTS, CONDITIONS AND RESTRICTIONS** (the "Declaration"). The Property is a part of a planned unit development known as **SARATOGA SPRINGS**

[Name of Planned Unit Development]

(the "PUD"). The Property also includes Borrower's interest in the homeowners association or equivalent entity owning or managing the common areas and facilities of the PUD (the "Owners Association") and the uses, benefits and proceeds of Borrower's interest.

**PUD COVENANTS.** In addition to the covenants and agreements made in the Security Instrument, Borrower and Lender further covenant and agree as follows:

**A. PUD Obligations.** Borrower shall perform all of Borrower's obligations under the PUD's Constituent Documents. The "Constituent Documents" are the (i) Declaration; (ii) articles of incorporation, trust instrument or any equivalent document which creates the Owners Association; and (iii) any by-laws or other rules or regulations of the Owners Association. Borrower shall promptly pay, when due, all dues and assessments imposed pursuant to the Constituent Documents.

**0054851365**

MULTISTATE PUD RIDER - Single Family - Fannie Mae/Freddie Mac UNIFORM INSTRUMENT Form 3150 1/01  
Page 1 of 3 Initials: *SR*

 -7R (0008)

VMP MORTGAGE FORMS - (800)521-7291



**B. Property Insurance.** So long as the Owners Association maintains, with a generally accepted insurance carrier, a "master" or "blanket" policy insuring the Property which is satisfactory to Lender and which provides insurance coverage in the amounts (including deductible levels), for the periods, and against loss by fire, hazards included within the term "extended coverage," and any other hazards, including, but not limited to, earthquakes and floods, for which Lender requires insurance, then: (i) Lender waives the provision in Section 3 for the Periodic Payment to Lender of the yearly premium installments for property insurance on the Property; and (ii) Borrower's obligation under Section 5 to maintain property insurance coverage on the Property is deemed satisfied to the extent that the required coverage is provided by the Owners Association policy.

What Lender requires as a condition of this waiver can change during the term of the loan.

Borrower shall give Lender prompt notice of any lapse in required property insurance coverage provided by the master or blanket policy.

In the event of a distribution of property insurance proceeds in lieu of restoration or repair following a loss to the Property, or to common areas and facilities of the PUD, any proceeds payable to Borrower are hereby assigned and shall be paid to Lender. Lender shall apply the proceeds to the sums secured by the Security Instrument, whether or not then due, with the excess, if any, paid to Borrower.

**C. Public Liability Insurance.** Borrower shall take such actions as may be reasonable to insure that the Owners Association maintains a public liability insurance policy acceptable in form, amount, and extent of coverage to Lender.

**D. Condemnation.** The proceeds of any award or claim for damages, direct or consequential, payable to Borrower in connection with any condemnation or other taking of all or any part of the Property or the common areas and facilities of the PUD, or for any conveyance in lieu of condemnation, are hereby assigned and shall be paid to Lender. Such proceeds shall be applied by Lender to the sums secured by the Security Instrument as provided in Section 11.

**E. Lender's Prior Consent.** Borrower shall not, except after notice to Lender and with Lender's prior written consent, either partition or subdivide the Property or consent to: (i) the abandonment or termination of the PUD, except for abandonment or termination required by law in the case of substantial destruction by fire or other casualty or in the case of a taking by condemnation or eminent domain; (ii) any amendment to any provision of the "Constituent Documents" if the provision is for the express benefit of Lender; (iii) termination of professional management and assumption of self-management of the Owners Association; or (iv) any action which would have the effect of rendering the public liability insurance coverage maintained by the Owners Association unacceptable to Lender.

**F. Remedies.** If Borrower does not pay PUD dues and assessments when due, then Lender may pay them. Any amounts disbursed by Lender under this paragraph F shall become additional debt of Borrower secured by the Security Instrument. Unless Borrower and Lender agree to other terms of payment, these amounts shall bear interest from the date of disbursement at the Note rate and shall be payable, with interest, upon notice from Lender to Borrower requesting payment.

VMP-7R (0008)

Page 2 of 3

Initials: SK

Form 3150 1/01

0647003 Page: 22 of 23 06/16/2005  
EK- 0605  
PG- 7050

BY SIGNING BELOW, Borrower accepts and agrees to the terms and provisions contained in this PUD Rider.

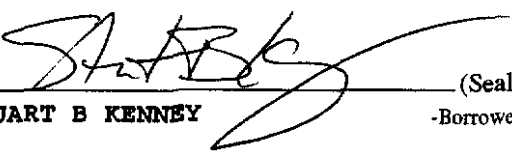
  
\_\_\_\_\_  
STUART B KENNEY (Seal)  
-Borrower

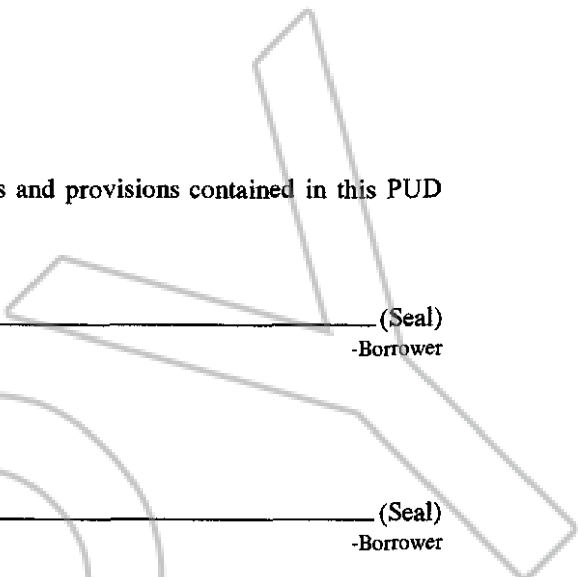
  
\_\_\_\_\_  
(Seal)  
-Borrower

\_\_\_\_\_  
(Seal)  
-Borrower

\_\_\_\_\_  
(Seal)  
-Borrower

\_\_\_\_\_  
(Seal)  
-Borrower

\_\_\_\_\_  
(Seal)  
-Borrower

\_\_\_\_\_  
(Seal)  
-Borrower

\_\_\_\_\_  
(Seal)  
-Borrower

 7R (0008)

Page 3 of 3

Form 3150 1/01

