

44

Financial Title Company
Escrow No: 41164409-276

DOC # 0667405
02/07/2006 10:07 AM Deputy: BC
OFFICIAL RECORD
Requested By:
LENDERS FIRST CHOICE

Assessor's Parcel Number:

Return To: ~~Downey Savings and Loan Association, F.A.
P.O. Box 6060, 3501 Jamboree Rd,
Newport Beach, CA 92658-6060~~

Lenders First Choice
3850 Royal Ave
Simi Valley, CA 93063

Douglas County - NV
Werner Christen - Recorder
Page: 1 of 31 Fee: 44.00
BK-0206 PG- 1991 RPTT: 0.00



Prepared By: Downey Savings and Loan Association, F.A.
P.O. Box 6060, 3501 Jamboree Rd,
Newport Beach, CA 92658-6060
Recording Requested By: Downey Savings and Loan Association, F.A.

37-5002205 [Space Above This Line For Recording Data]

Title Order No.: 4164408-276-
Escrow No.: 41164409-276-
APN: 1319-19-212-055
DEED OF TRUST

DEFINITIONS

Words used in multiple sections of this document are defined below and other words are defined in Sections 3, 11, 13, 18, 20 and 21. Certain rules regarding the usage of words used in this document are also provided in Section 16.

- (A) "Security Instrument" means this document, which is dated **January 6, 2006** together with all Riders to this document.
- (B) "Borrower" is **CORY J OTTERNESS, A Single Man**

Borrower is the trustor under this Security Instrument.
(C) "Lender" is **Downey Savings and Loan Association, F.A.**

Lender is a **federally chartered savings association** organized and existing under the laws of **the United States of America**

9042077446

NEVADA-Single Family-Fannie Mae/Freddie Mac UNIFORM INSTRUMENT Form 3029 1/01

Lender's address is 3501 Jamboree Road, Newport Beach, CA 92660

Lender is the beneficiary under this Security Instrument.

(D) "Trustee" is DSL Service Company, A California Corporation

(E) "Note" means the promissory note signed by Borrower and dated January 6, 2006. The Note states that Borrower owes Lender one hundred sixty-seven thousand and 00/100 Dollars

(U.S. \$167,000.00) plus interest. Borrower has promised to pay this debt in regular Periodic Payments and to pay the debt in full not later than February 1, 2046

(F) "Property" means the property that is described below under the heading "Transfer of Rights in the Property."

(G) "Loan" means the debt evidenced by the Note, plus interest, any prepayment charges and late charges due under the Note, and all sums due under this Security Instrument, plus interest.

(H) "Riders" means all Riders to this Security Instrument that are executed by Borrower. The following Riders are to be executed by Borrower [check box as applicable]:

- Adjustable Rate Rider
- Balloon Rider
- VA Rider
- Condominium Rider
- Planned Unit Development Rider
- Biweekly Payment Rider
- Second Home Rider
- 1-4 Family Rider
- Other(s) [specify]

Rider to Promissory Note and Security Instrument

(I) "Applicable Law" means all controlling applicable federal, state and local statutes, regulations, ordinances and administrative rules and orders (that have the effect of law) as well as all applicable final, non-appealable judicial opinions.

(J) "Community Association Dues, Fees, and Assessments" means all dues, fees, assessments and other charges that are imposed on Borrower or the Property by a condominium association, homeowners association or similar organization.

(K) "Electronic Funds Transfer" means any transfer of funds, other than a transaction originated by check, draft, or similar paper instrument, which is initiated through an electronic terminal, telephonic instrument, computer, or magnetic tape so as to order, instruct, or authorize a financial institution to debit or credit an account. Such term includes, but is not limited to, point-of-sale transfers, automated teller machine transactions, transfers initiated by telephone, wire transfers, and automated clearinghouse transfers.

(L) "Escrow Items" means those items that are described in Section 3.

(M) "Miscellaneous Proceeds" means any compensation, settlement, award of damages, or proceeds paid by any third party (other than insurance proceeds paid under the coverages described in Section 5) for: (i) damage to, or destruction of, the Property; (ii) condemnation or other taking of all or any part of the Property; (iii) conveyance in lieu of condemnation; or (iv) misrepresentations of, or omissions as to, the value and/or condition of the Property.

(N) "Mortgage Insurance" means insurance protecting Lender against the nonpayment of, or default on, the Loan.

(O) "Periodic Payment" means the regularly scheduled amount due for (i) principal and interest under the Note, plus (ii) any amounts under Section 3 of this Security Instrument.

(P) "RESPA" means the Real Estate Settlement Procedures Act (12 U.S.C. Section 2601 et seq.) and its implementing regulation, Regulation X (24 C.F.R. Part 3500), as they might be amended from time to time, or any additional or successor legislation or regulation that governs the same subject matter. As used in this Security Instrument, "RESPA" refers to all requirements and restrictions that are imposed in regard

Initials: *gjo*



to a "federally related mortgage loan" even if the Loan does not qualify as a "federally related mortgage loan" under RESPA.

(Q) "Successor in Interest of Borrower" means any party that has taken title to the Property, whether or not that party has assumed Borrower's obligations under the Note and/or this Security Instrument.

TRANSFER OF RIGHTS IN THE PROPERTY

This Security Instrument secures to Lender: (i) the repayment of the Loan, and all renewals, extensions and modifications of the Note; and (ii) the performance of Borrower's covenants and agreements under this Security Instrument and the Note. For this purpose, Borrower irrevocably grants and conveys to Trustee, in trust, with power of sale, the following described property located in the County of Douglas :

[Type of Recording Jurisdiction]

[Name of Recording Jurisdiction]

Legal Description attached hereto and made a part hereof

Parcel ID Number:

**720-B TINA COURT
STATELINE**

("Property Address"):

which currently has the address of

[City], Nevada **89449** [Street] [Zip Code]

TOGETHER WITH all the improvements now or hereafter erected on the property, and all easements, appurtenances, and fixtures now or hereafter a part of the property. All replacements and additions shall also be covered by this Security Instrument. All of the foregoing is referred to in this Security Instrument as the "Property."

BORROWER COVENANTS that Borrower is lawfully seised of the estate hereby conveyed and has the right to grant and convey the Property and that the Property is unencumbered, except for encumbrances of record. Borrower warrants and will defend generally the title to the Property against all claims and demands, subject to any encumbrances of record.

THIS SECURITY INSTRUMENT combines uniform covenants for national use and non-uniform covenants with limited variations by jurisdiction to constitute a uniform security instrument covering real property.

UNIFORM COVENANTS. Borrower and Lender covenant and agree as follows:

1. Payment of Principal, Interest, Escrow Items, Prepayment Charges, and Late Charges. Borrower shall pay when due the principal of, and interest on, the debt evidenced by the Note and any prepayment charges and late charges due under the Note. Borrower shall also pay funds for Escrow Items

9042077446

Initials: *EP*



pursuant to Section 3. Payments due under the Note and this Security Instrument shall be made in U.S. currency. However, if any check or other instrument received by Lender as payment under the Note or this Security Instrument is returned to Lender unpaid, Lender may require that any or all subsequent payments due under the Note and this Security Instrument be made in one or more of the following forms, as selected by Lender: (a) cash; (b) money order; (c) certified check, bank check, treasurer's check or cashier's check, provided any such check is drawn upon an institution whose deposits are insured by a federal agency, instrumentality, or entity; or (d) Electronic Funds Transfer.

Payments are deemed received by Lender when received at the location designated in the Note or at such other location as may be designated by Lender in accordance with the notice provisions in Section 15. Lender may return any payment or partial payment if the payment or partial payments are insufficient to bring the Loan current. Lender may accept any payment or partial payment insufficient to bring the Loan current, without waiver of any rights hereunder or prejudice to its rights to refuse such payment or partial payments in the future, but Lender is not obligated to apply such payments at the time such payments are accepted. If each Periodic Payment is applied as of its scheduled due date, then Lender need not pay interest on unapplied funds. Lender may hold such unapplied funds until Borrower makes payment to bring the Loan current. If Borrower does not do so within a reasonable period of time, Lender shall either apply such funds or return them to Borrower. If not applied earlier, such funds will be applied to the outstanding principal balance under the Note immediately prior to foreclosure. No offset or claim which Borrower might have now or in the future against Lender shall relieve Borrower from making payments due under the Note and this Security Instrument or performing the covenants and agreements secured by this Security Instrument.

2. Application of Payments or Proceeds. Except as otherwise described in this Section 2, all payments accepted and applied by Lender shall be applied in the following order of priority: (a) interest due under the Note; (b) principal due under the Note; (c) amounts due under Section 3. Such payments shall be applied to each Periodic Payment in the order in which it became due. Any remaining amounts shall be applied first to late charges, second to any other amounts due under this Security Instrument, and then to reduce the principal balance of the Note.

If Lender receives a payment from Borrower for a delinquent Periodic Payment which includes a sufficient amount to pay any late charge due, the payment may be applied to the delinquent payment and the late charge. If more than one Periodic Payment is outstanding, Lender may apply any payment received from Borrower to the repayment of the Periodic Payments if, and to the extent that, each payment can be paid in full. To the extent that any excess exists after the payment is applied to the full payment of one or more Periodic Payments, such excess may be applied to any late charges due. Voluntary prepayments shall be applied first to any prepayment charges and then as described in the Note.

Any application of payments, insurance proceeds, or Miscellaneous Proceeds to principal due under the Note shall not extend or postpone the due date, or change the amount, of the Periodic Payments.

3. Funds for Escrow Items. Borrower shall pay to Lender on the day Periodic Payments are due under the Note, until the Note is paid in full, a sum (the "Funds") to provide for payment of amounts due for: (a) taxes and assessments and other items which can attain priority over this Security Instrument as a lien or encumbrance on the Property; (b) leasehold payments or ground rents on the Property, if any; (c) premiums for any and all insurance required by Lender under Section 5; and (d) Mortgage Insurance premiums, if any, or any sums payable by Borrower to Lender in lieu of the payment of Mortgage Insurance premiums in accordance with the provisions of Section 10. These items are called "Escrow Items." At origination or at any time during the term of the Loan, Lender may require that Community Association Dues, Fees, and Assessments, if any, be escrowed by Borrower, and such dues, fees and assessments shall be an Escrow Item. Borrower shall promptly furnish to Lender all notices of amounts to be paid under this Section. Borrower shall pay Lender the Funds for Escrow Items unless Lender waives Borrower's obligation to pay the Funds for any or all Escrow Items. Lender may waive Borrower's obligation to pay to Lender Funds for any or all Escrow Items at any time. Any such waiver may only be

9042077446



in writing. In the event of such waiver, Borrower shall pay directly, when and where payable, the amounts due for any Escrow Items for which payment of Funds has been waived by Lender and, if Lender requires, shall furnish to Lender receipts evidencing such payment within such time period as Lender may require. Borrower's obligation to make such payments and to provide receipts shall for all purposes be deemed to be a covenant and agreement contained in this Security Instrument, as the phrase "covenant and agreement" is used in Section 9. If Borrower is obligated to pay Escrow Items directly, pursuant to a waiver, and Borrower fails to pay the amount due for an Escrow Item, Lender may exercise its rights under Section 9 and pay such amount and Borrower shall then be obligated under Section 9 to repay to Lender any such amount. Lender may revoke the waiver as to any or all Escrow Items at any time by a notice given in accordance with Section 15 and, upon such revocation, Borrower shall pay to Lender all Funds, and in such amounts, that are then required under this Section 3.

Lender may, at any time, collect and hold Funds in an amount (a) sufficient to permit Lender to apply the Funds at the time specified under RESPA, and (b) not to exceed the maximum amount a lender can require under RESPA. Lender shall estimate the amount of Funds due on the basis of current data and reasonable estimates of expenditures of future Escrow Items or otherwise in accordance with Applicable Law.

The Funds shall be held in an institution whose deposits are insured by a federal agency, instrumentality, or entity (including Lender, if Lender is an institution whose deposits are so insured) or in any Federal Home Loan Bank. Lender shall apply the Funds to pay the Escrow Items no later than the time specified under RESPA. Lender shall not charge Borrower for holding and applying the Funds, annually analyzing the escrow account, or verifying the Escrow Items, unless Lender pays Borrower interest on the Funds and Applicable Law permits Lender to make such a charge. Unless an agreement is made in writing or Applicable Law requires interest to be paid on the Funds, Lender shall not be required to pay Borrower any interest or earnings on the Funds. Borrower and Lender can agree in writing, however, that interest shall be paid on the Funds. Lender shall give to Borrower, without charge, an annual accounting of the Funds as required by RESPA.

If there is a surplus of Funds held in escrow, as defined under RESPA, Lender shall account to Borrower for the excess funds in accordance with RESPA. If there is a shortage of Funds held in escrow, as defined under RESPA, Lender shall notify Borrower as required by RESPA, and Borrower shall pay to Lender the amount necessary to make up the shortage in accordance with RESPA, but in no more than 12 monthly payments. If there is a deficiency of Funds held in escrow, as defined under RESPA, Lender shall notify Borrower as required by RESPA, and Borrower shall pay to Lender the amount necessary to make up the deficiency in accordance with RESPA, but in no more than 12 monthly payments.

Upon payment in full of all sums secured by this Security Instrument, Lender shall promptly refund to Borrower any Funds held by Lender.

4. Charges; Liens. Borrower shall pay all taxes, assessments, charges, fines, and impositions attributable to the Property which can attain priority over this Security Instrument, leasehold payments or ground rents on the Property, if any, and Community Association Dues, Fees, and Assessments, if any. To the extent that these items are Escrow Items, Borrower shall pay them in the manner provided in Section 3.

Borrower shall promptly discharge any lien which has priority over this Security Instrument unless Borrower: (a) agrees in writing to the payment of the obligation secured by the lien in a manner acceptable to Lender, but only so long as Borrower is performing such agreement; (b) contests the lien in good faith by, or defends against enforcement of the lien in, legal proceedings which in Lender's opinion operate to prevent the enforcement of the lien while those proceedings are pending, but only until such proceedings are concluded; or (c) secures from the holder of the lien an agreement satisfactory to Lender subordinating the lien to this Security Instrument. If Lender determines that any part of the Property is subject to a lien which can attain priority over this Security Instrument, Lender may give Borrower a notice identifying the



lien. Within 10 days of the date on which that notice is given, Borrower shall satisfy the lien or take one or more of the actions set forth above in this Section 4.

Lender may require Borrower to pay a one-time charge for a real estate tax verification and/or reporting service used by Lender in connection with this Loan.

5. Property Insurance. Borrower shall keep the improvements now existing or hereafter erected on the Property insured against loss by fire, hazards included within the term "extended coverage," and any other hazards including, but not limited to, earthquakes and floods, for which Lender requires insurance. This insurance shall be maintained in the amounts (including deductible levels) and for the periods that Lender requires. What Lender requires pursuant to the preceding sentences can change during the term of the Loan. The insurance carrier providing the insurance shall be chosen by Borrower subject to Lender's right to disapprove Borrower's choice, which right shall not be exercised unreasonably. Lender may require Borrower to pay, in connection with this Loan, either: (a) a one-time charge for flood zone determination, certification and tracking services; or (b) a one-time charge for flood zone determination and certification services and subsequent charges each time remappings or similar changes occur which reasonably might affect such determination or certification. Borrower shall also be responsible for the payment of any fees imposed by the Federal Emergency Management Agency in connection with the review of any flood zone determination resulting from an objection by Borrower.

If Borrower fails to maintain any of the coverages described above, Lender may obtain insurance coverage, at Lender's option and Borrower's expense. Lender is under no obligation to purchase any particular type or amount of coverage. Therefore, such coverage shall cover Lender, but might or might not protect Borrower, Borrower's equity in the Property, or the contents of the Property, against any risk, hazard or liability and might provide greater or lesser coverage than was previously in effect. Borrower acknowledges that the cost of the insurance coverage so obtained might significantly exceed the cost of insurance that Borrower could have obtained. Any amounts disbursed by Lender under this Section 5 shall become additional debt of Borrower secured by this Security Instrument. These amounts shall bear interest at the Note rate from the date of disbursement and shall be payable, with such interest, upon notice from Lender to Borrower requesting payment.

All insurance policies required by Lender and renewals of such policies shall be subject to Lender's right to disapprove such policies, shall include a standard mortgage clause, and shall name Lender as mortgagee and/or as an additional loss payee. Lender shall have the right to hold the policies and renewal certificates. If Lender requires, Borrower shall promptly give to Lender all receipts of paid premiums and renewal notices. If Borrower obtains any form of insurance coverage, not otherwise required by Lender, for damage to, or destruction of, the Property, such policy shall include a standard mortgage clause and shall name Lender as mortgagee and/or as an additional loss payee.

In the event of loss, Borrower shall give prompt notice to the insurance carrier and Lender. Lender may make proof of loss if not made promptly by Borrower. Unless Lender and Borrower otherwise agree in writing, any insurance proceeds, whether or not the underlying insurance was required by Lender, shall be applied to restoration or repair of the Property, if the restoration or repair is economically feasible and Lender's security is not lessened. During such repair and restoration period, Lender shall have the right to hold such insurance proceeds until Lender has had an opportunity to inspect such Property to ensure the work has been completed to Lender's satisfaction, provided that such inspection shall be undertaken promptly. Lender may disburse proceeds for the repairs and restoration in a single payment or in a series of progress payments as the work is completed. Unless an agreement is made in writing or Applicable Law requires interest to be paid on such insurance proceeds, Lender shall not be required to pay Borrower any interest or earnings on such proceeds. Fees for public adjusters, or other third parties, retained by Borrower shall not be paid out of the insurance proceeds and shall be the sole obligation of Borrower. If the restoration or repair is not economically feasible or Lender's security would be lessened, the insurance proceeds shall be applied to the sums secured by this Security Instrument, whether or not then due, with



the excess, if any, paid to Borrower. Such insurance proceeds shall be applied in the order provided for in Section 2.

If Borrower abandons the Property, Lender may file, negotiate and settle any available insurance claim and related matters. If Borrower does not respond within 30 days to a notice from Lender that the insurance carrier has offered to settle a claim, then Lender may negotiate and settle the claim. The 30-day period will begin when the notice is given. In either event, or if Lender acquires the Property under Section 22 or otherwise, Borrower hereby assigns to Lender (a) Borrower's rights to any insurance proceeds in an amount not to exceed the amounts unpaid under the Note or this Security Instrument, and (b) any other of Borrower's rights (other than the right to any refund of unearned premiums paid by Borrower) under all insurance policies covering the Property, insofar as such rights are applicable to the coverage of the Property. Lender may use the insurance proceeds either to repair or restore the Property or to pay amounts unpaid under the Note or this Security Instrument, whether or not then due.

6. Occupancy. Borrower shall occupy, establish, and use the Property as Borrower's principal residence within 60 days after the execution of this Security Instrument and shall continue to occupy the Property as Borrower's principal residence for at least one year after the date of occupancy, unless Lender otherwise agrees in writing, which consent shall not be unreasonably withheld, or unless extenuating circumstances exist which are beyond Borrower's control.

7. Preservation, Maintenance and Protection of the Property; Inspections. Borrower shall not destroy, damage or impair the Property, allow the Property to deteriorate or commit waste on the Property. Whether or not Borrower is residing in the Property, Borrower shall maintain the Property in order to prevent the Property from deteriorating or decreasing in value due to its condition. Unless it is determined pursuant to Section 5 that repair or restoration is not economically feasible, Borrower shall promptly repair the Property if damaged to avoid further deterioration or damage. If insurance or condemnation proceeds are paid in connection with damage to, or the taking of, the Property, Borrower shall be responsible for repairing or restoring the Property only if Lender has released proceeds for such purposes. Lender may disburse proceeds for the repairs and restoration in a single payment or in a series of progress payments as the work is completed. If the insurance or condemnation proceeds are not sufficient to repair or restore the Property, Borrower is not relieved of Borrower's obligation for the completion of such repair or restoration.

Lender or its agent may make reasonable entries upon and inspections of the Property. If it has reasonable cause, Lender may inspect the interior of the improvements on the Property. Lender shall give Borrower notice at the time of or prior to such an interior inspection specifying such reasonable cause.

8. Borrower's Loan Application. Borrower shall be in default if, during the Loan application process, Borrower or any persons or entities acting at the direction of Borrower or with Borrower's knowledge or consent gave materially false, misleading, or inaccurate information or statements to Lender (or failed to provide Lender with material information) in connection with the Loan. Material representations include, but are not limited to, representations concerning Borrower's occupancy of the Property as Borrower's principal residence.

9. Protection of Lender's Interest in the Property and Rights Under this Security Instrument. If (a) Borrower fails to perform the covenants and agreements contained in this Security Instrument, (b) there is a legal proceeding that might significantly affect Lender's interest in the Property and/or rights under this Security Instrument (such as a proceeding in bankruptcy, probate, for condemnation or forfeiture, for enforcement of a lien which may attain priority over this Security Instrument or to enforce laws or regulations), or (c) Borrower has abandoned the Property, then Lender may do and pay for whatever is reasonable or appropriate to protect Lender's interest in the Property and rights under this Security Instrument, including protecting and/or assessing the value of the Property, and securing and/or repairing the Property. Lender's actions can include, but are not limited to: (a) paying any sums secured by a lien which has priority over this Security Instrument; (b) appearing in court; and (c) paying reasonable



attorneys' fees to protect its interest in the Property and/or rights under this Security Instrument, including its secured position in a bankruptcy proceeding. Securing the Property includes, but is not limited to, entering the Property to make repairs, change locks, replace or board up doors and windows, drain water from pipes, eliminate building or other code violations or dangerous conditions, and have utilities turned on or off. Although Lender may take action under this Section 9, Lender does not have to do so and is not under any duty or obligation to do so. It is agreed that Lender incurs no liability for not taking any or all actions authorized under this Section 9.

Any amounts disbursed by Lender under this Section 9 shall become additional debt of Borrower secured by this Security Instrument. These amounts shall bear interest at the Note rate from the date of disbursement and shall be payable, with such interest, upon notice from Lender to Borrower requesting payment.

If this Security Instrument is on a leasehold, Borrower shall comply with all the provisions of the lease. If Borrower acquires fee title to the Property, the leasehold and the fee title shall not merge unless Lender agrees to the merger in writing.

10. Mortgage Insurance. If Lender required Mortgage Insurance as a condition of making the Loan, Borrower shall pay the premiums required to maintain the Mortgage Insurance in effect. If, for any reason, the Mortgage Insurance coverage required by Lender ceases to be available from the mortgage insurer that previously provided such insurance and Borrower was required to make separately designated payments toward the premiums for Mortgage Insurance, Borrower shall pay the premiums required to obtain coverage substantially equivalent to the Mortgage Insurance previously in effect, at a cost substantially equivalent to the cost to Borrower of the Mortgage Insurance previously in effect, from an alternate mortgage insurer selected by Lender. If substantially equivalent Mortgage Insurance coverage is not available, Borrower shall continue to pay to Lender the amount of the separately designated payments that were due when the insurance coverage ceased to be in effect. Lender will accept, use and retain these payments as a non-refundable loss reserve in lieu of Mortgage Insurance. Such loss reserve shall be non-refundable, notwithstanding the fact that the Loan is ultimately paid in full, and Lender shall not be required to pay Borrower any interest or earnings on such loss reserve. Lender can no longer require loss reserve payments if Mortgage Insurance coverage (in the amount and for the period that Lender requires) provided by an insurer selected by Lender again becomes available, is obtained, and Lender requires separately designated payments toward the premiums for Mortgage Insurance. If Lender required Mortgage Insurance as a condition of making the Loan and Borrower was required to make separately designated payments toward the premiums for Mortgage Insurance, Borrower shall pay the premiums required to maintain Mortgage Insurance in effect, or to provide a non-refundable loss reserve, until Lender's requirement for Mortgage Insurance ends in accordance with any written agreement between Borrower and Lender providing for such termination or until termination is required by Applicable Law. Nothing in this Section 10 affects Borrower's obligation to pay interest at the rate provided in the Note.

Mortgage Insurance reimburses Lender (or any entity that purchases the Note) for certain losses it may incur if Borrower does not repay the Loan as agreed. Borrower is not a party to the Mortgage Insurance.

Mortgage insurers evaluate their total risk on all such insurance in force from time to time, and may enter into agreements with other parties that share or modify their risk, or reduce losses. These agreements are on terms and conditions that are satisfactory to the mortgage insurer and the other party (or parties) to these agreements. These agreements may require the mortgage insurer to make payments using any source of funds that the mortgage insurer may have available (which may include funds obtained from Mortgage Insurance premiums).

As a result of these agreements, Lender, any purchaser of the Note, another insurer, any reinsurer, any other entity, or any affiliate of any of the foregoing, may receive (directly or indirectly) amounts that derive from (or might be characterized as) a portion of Borrower's payments for Mortgage Insurance, in exchange for sharing or modifying the mortgage insurer's risk, or reducing losses. If such agreement provides that an affiliate of Lender takes a share of the insurer's risk in exchange for a share of the premiums paid to the insurer, the arrangement is often termed "captive reinsurance." Further:

(a) Any such agreements will not affect the amounts that Borrower has agreed to pay for Mortgage Insurance, or any other terms of the Loan. Such agreements will not increase the amount Borrower will owe for Mortgage Insurance, and they will not entitle Borrower to any refund.



(b) Any such agreements will not affect the rights Borrower has - if any - with respect to the Mortgage Insurance under the Homeowners Protection Act of 1998 or any other law. These rights may include the right to receive certain disclosures, to request and obtain cancellation of the Mortgage Insurance, to have the Mortgage Insurance terminated automatically, and/or to receive a refund of any Mortgage Insurance premiums that were unearned at the time of such cancellation or termination.

11. Assignment of Miscellaneous Proceeds; Forfeiture. All Miscellaneous Proceeds are hereby assigned to and shall be paid to Lender.

If the Property is damaged, such Miscellaneous Proceeds shall be applied to restoration or repair of the Property, if the restoration or repair is economically feasible and Lender's security is not lessened. During such repair and restoration period, Lender shall have the right to hold such Miscellaneous Proceeds until Lender has had an opportunity to inspect such Property to ensure the work has been completed to Lender's satisfaction, provided that such inspection shall be undertaken promptly. Lender may pay for the repairs and restoration in a single disbursement or in a series of progress payments as the work is completed. Unless an agreement is made in writing or Applicable Law requires interest to be paid on such Miscellaneous Proceeds, Lender shall not be required to pay Borrower any interest or earnings on such Miscellaneous Proceeds. If the restoration or repair is not economically feasible or Lender's security would be lessened, the Miscellaneous Proceeds shall be applied to the sums secured by this Security Instrument, whether or not then due, with the excess, if any, paid to Borrower. Such Miscellaneous Proceeds shall be applied in the order provided for in Section 2.

In the event of a total taking, destruction, or loss in value of the Property, the Miscellaneous Proceeds shall be applied to the sums secured by this Security Instrument, whether or not then due, with the excess, if any, paid to Borrower.

In the event of a partial taking, destruction, or loss in value of the Property in which the fair market value of the Property immediately before the partial taking, destruction, or loss in value is equal to or greater than the amount of the sums secured by this Security Instrument immediately before the partial taking, destruction, or loss in value, unless Borrower and Lender otherwise agree in writing, the sums secured by this Security Instrument shall be reduced by the amount of the Miscellaneous Proceeds multiplied by the following fraction: (a) the total amount of the sums secured immediately before the partial taking, destruction, or loss in value divided by (b) the fair market value of the Property immediately before the partial taking, destruction, or loss in value. Any balance shall be paid to Borrower.

In the event of a partial taking, destruction, or loss in value of the Property in which the fair market value of the Property immediately before the partial taking, destruction, or loss in value is less than the amount of the sums secured immediately before the partial taking, destruction, or loss in value, unless Borrower and Lender otherwise agree in writing, the Miscellaneous Proceeds shall be applied to the sums secured by this Security Instrument whether or not the sums are then due.

If the Property is abandoned by Borrower, or if, after notice by Lender to Borrower that the Opposing Party (as defined in the next sentence) offers to make an award to settle a claim for damages, Borrower fails to respond to Lender within 30 days after the date the notice is given, Lender is authorized to collect and apply the Miscellaneous Proceeds either to restoration or repair of the Property or to the sums secured by this Security Instrument, whether or not then due. "Opposing Party" means the third party that owes Borrower Miscellaneous Proceeds or the party against whom Borrower has a right of action in regard to Miscellaneous Proceeds.

Borrower shall be in default if any action or proceeding, whether civil or criminal, is begun that, in Lender's judgment, could result in forfeiture of the Property or other material impairment of Lender's interest in the Property or rights under this Security Instrument. Borrower can cure such a default and, if acceleration has occurred, reinstate as provided in Section 19, by causing the action or proceeding to be dismissed with a ruling that, in Lender's judgment, precludes forfeiture of the Property or other material impairment of Lender's interest in the Property or rights under this Security Instrument. The proceeds of any award or claim for damages that are attributable to the impairment of Lender's interest in the Property are hereby assigned and shall be paid to Lender.

All Miscellaneous Proceeds that are not applied to restoration or repair of the Property shall be applied in the order provided for in Section 2.



12. Borrower Not Released; Forbearance By Lender Not a Waiver. Extension of the time for payment or modification of amortization of the sums secured by this Security Instrument granted by Lender to Borrower or any Successor in Interest of Borrower shall not operate to release the liability of Borrower or any Successors in Interest of Borrower. Lender shall not be required to commence proceedings against any Successor in Interest of Borrower or to refuse to extend time for payment or otherwise modify amortization of the sums secured by this Security Instrument by reason of any demand made by the original Borrower or any Successors in Interest of Borrower. Any forbearance by Lender in exercising any right or remedy including, without limitation, Lender's acceptance of payments from third persons, entities or Successors in Interest of Borrower or in amounts less than the amount then due, shall not be a waiver of or preclude the exercise of any right or remedy.

13. Joint and Several Liability; Co-signers; Successors and Assigns Bound. Borrower covenants and agrees that Borrower's obligations and liability shall be joint and several. However, any Borrower who co-signs this Security Instrument but does not execute the Note (a "co-signer"): (a) is co-signing this Security Instrument only to mortgage, grant and convey the co-signer's interest in the Property under the terms of this Security Instrument; (b) is not personally obligated to pay the sums secured by this Security Instrument; and (c) agrees that Lender and any other Borrower can agree to extend, modify, forbear or make any accommodations with regard to the terms of this Security Instrument or the Note without the co-signer's consent.

Subject to the provisions of Section 18, any Successor in Interest of Borrower who assumes Borrower's obligations under this Security Instrument in writing, and is approved by Lender, shall obtain all of Borrower's rights and benefits under this Security Instrument. Borrower shall not be released from Borrower's obligations and liability under this Security Instrument unless Lender agrees to such release in writing. The covenants and agreements of this Security Instrument shall bind (except as provided in Section 20) and benefit the successors and assigns of Lender.

14. Loan Charges. Lender may charge Borrower fees for services performed in connection with Borrower's default, for the purpose of protecting Lender's interest in the Property and rights under this Security Instrument, including, but not limited to, attorneys' fees, property inspection and valuation fees. In regard to any other fees, the absence of express authority in this Security Instrument to charge a specific fee to Borrower shall not be construed as a prohibition on the charging of such fee. Lender may not charge fees that are expressly prohibited by this Security Instrument or by Applicable Law.

If the Loan is subject to a law which sets maximum loan charges, and that law is finally interpreted so that the interest or other loan charges collected or to be collected in connection with the Loan exceed the permitted limits, then: (a) any such loan charge shall be reduced by the amount necessary to reduce the charge to the permitted limit; and (b) any sums already collected from Borrower which exceeded permitted limits will be refunded to Borrower. Lender may choose to make this refund by reducing the principal owed under the Note or by making a direct payment to Borrower. If a refund reduces principal, the reduction will be treated as a partial prepayment without any prepayment charge (whether or not a prepayment charge is provided for under the Note). Borrower's acceptance of any such refund made by direct payment to Borrower will constitute a waiver of any right of action Borrower might have arising out of such overcharge.

15. Notices. All notices given by Borrower or Lender in connection with this Security Instrument must be in writing. Any notice to Borrower in connection with this Security Instrument shall be deemed to have been given to Borrower when mailed by first class mail or when actually delivered to Borrower's notice address if sent by other means. Notice to any one Borrower shall constitute notice to all Borrowers unless Applicable Law expressly requires otherwise. The notice address shall be the Property Address unless Borrower has designated a substitute notice address by notice to Lender. Borrower shall promptly notify Lender of Borrower's change of address. If Lender specifies a procedure for reporting Borrower's change of address, then Borrower shall only report a change of address through that specified procedure. There may be only one designated notice address under this Security Instrument at any one time. Any notice to Lender shall be given by delivering it or by mailing it by first class mail to Lender's address stated herein unless Lender has designated another address by notice to Borrower. Any notice in connection with this Security Instrument shall not be deemed to have been given to Lender until actually received by Lender. If any notice required by this Security Instrument is also required under Applicable Law, the Applicable Law requirement will satisfy the corresponding requirement under this Security Instrument.



16. Governing Law; Severability; Rules of Construction. This Security Instrument shall be governed by federal law and the law of the jurisdiction in which the Property is located. All rights and obligations contained in this Security Instrument are subject to any requirements and limitations of Applicable Law. Applicable Law might explicitly or implicitly allow the parties to agree by contract or it might be silent, but such silence shall not be construed as a prohibition against agreement by contract. In the event that any provision or clause of this Security Instrument or the Note conflicts with Applicable Law, such conflict shall not affect other provisions of this Security Instrument or the Note which can be given effect without the conflicting provision.

As used in this Security Instrument: (a) words of the masculine gender shall mean and include corresponding neuter words or words of the feminine gender; (b) words in the singular shall mean and include the plural and vice versa; and (c) the word "may" gives sole discretion without any obligation to take any action.

17. Borrower's Copy. Borrower shall be given one copy of the Note and of this Security Instrument.

18. Transfer of the Property or a Beneficial Interest in Borrower. As used in this Section 18, "Interest in the Property" means any legal or beneficial interest in the Property, including, but not limited to, those beneficial interests transferred in a bond for deed, contract for deed, installment sales contract or escrow agreement, the intent of which is the transfer of title by Borrower at a future date to a purchaser.

If all or any part of the Property or any Interest in the Property is sold or transferred (or if Borrower is not a natural person and a beneficial interest in Borrower is sold or transferred) without Lender's prior written consent, Lender may require immediate payment in full of all sums secured by this Security Instrument. However, this option shall not be exercised by Lender if such exercise is prohibited by Applicable Law.

If Lender exercises this option, Lender shall give Borrower notice of acceleration. The notice shall provide a period of not less than 30 days from the date the notice is given in accordance with Section 15 within which Borrower must pay all sums secured by this Security Instrument. If Borrower fails to pay these sums prior to the expiration of this period, Lender may invoke any remedies permitted by this Security Instrument without further notice or demand on Borrower.

19. Borrower's Right to Reinstate After Acceleration. If Borrower meets certain conditions, Borrower shall have the right to have enforcement of this Security Instrument discontinued at any time prior to the earliest of: (a) five days before sale of the Property pursuant to any power of sale contained in this Security Instrument; (b) such other period as Applicable Law might specify for the termination of Borrower's right to reinstate; or (c) entry of a judgment enforcing this Security Instrument. Those conditions are that Borrower: (a) pays Lender all sums which then would be due under this Security Instrument and the Note as if no acceleration had occurred; (b) cures any default of any other covenants or agreements; (c) pays all expenses incurred in enforcing this Security Instrument, including, but not limited to, reasonable attorneys' fees, property inspection and valuation fees, and other fees incurred for the purpose of protecting Lender's interest in the Property and rights under this Security Instrument; and (d) takes such action as Lender may reasonably require to assure that Lender's interest in the Property and rights under this Security Instrument, and Borrower's obligation to pay the sums secured by this Security Instrument, shall continue unchanged. Lender may require that Borrower pay such reinstatement sums and expenses in one or more of the following forms, as selected by Lender: (a) cash; (b) money order; (c) certified check, bank check, treasurer's check or cashier's check, provided any such check is drawn upon an institution whose deposits are insured by a federal agency, instrumentality or entity; or (d) Electronic Funds Transfer. Upon reinstatement by Borrower, this Security Instrument and obligations secured hereby shall remain fully effective as if no acceleration had occurred. However, this right to reinstate shall not apply in the case of acceleration under Section 18.

20. Sale of Note; Change of Loan Servicer; Notice of Grievance. The Note or a partial interest in the Note (together with this Security Instrument) can be sold one or more times without prior notice to Borrower. A sale might result in a change in the entity (known as the "Loan Servicer") that collects Periodic Payments due under the Note and this Security Instrument and performs other mortgage loan servicing obligations under the Note, this Security Instrument, and Applicable Law. There also might be

one or more changes of the Loan Servicer unrelated to a sale of the Note. If there is a change of the Loan Servicer, Borrower will be given written notice of the change which will state the name and address of the new Loan Servicer, the address to which payments should be made and any other information RESPA requires in connection with a notice of transfer of servicing. If the Note is sold and thereafter the Loan is serviced by a Loan Servicer other than the purchaser of the Note, the mortgage loan servicing obligations to Borrower will remain with the Loan Servicer or be transferred to a successor Loan Servicer and are not assumed by the Note purchaser unless otherwise provided by the Note purchaser.

Neither Borrower nor Lender may commence, join, or be joined to any judicial action (as either an individual litigant or the member of a class) that arises from the other party's actions pursuant to this Security Instrument or that alleges that the other party has breached any provision of, or any duty owed by reason of, this Security Instrument, until such Borrower or Lender has notified the other party (with such notice given in compliance with the requirements of Section 15) of such alleged breach and afforded the other party hereto a reasonable period after the giving of such notice to take corrective action. If Applicable Law provides a time period which must elapse before certain action can be taken, that time period will be deemed to be reasonable for purposes of this paragraph. The notice of acceleration and opportunity to cure given to Borrower pursuant to Section 22 and the notice of acceleration given to Borrower pursuant to Section 18 shall be deemed to satisfy the notice and opportunity to take corrective action provisions of this Section 20.

21. Hazardous Substances. As used in this Section 21: (a) "Hazardous Substances" are those substances defined as toxic or hazardous substances, pollutants, or wastes by Environmental Law and the following substances: gasoline, kerosene, other flammable or toxic petroleum products, toxic pesticides and herbicides, volatile solvents, materials containing asbestos or formaldehyde, and radioactive materials; (b) "Environmental Law" means federal laws and laws of the jurisdiction where the Property is located that relate to health, safety or environmental protection; (c) "Environmental Cleanup" includes any response action, remedial action, or removal action, as defined in Environmental Law; and (d) an "Environmental Condition" means a condition that can cause, contribute to, or otherwise trigger an Environmental Cleanup.

Borrower shall not cause or permit the presence, use, disposal, storage, or release of any Hazardous Substances, or threaten to release any Hazardous Substances, on or in the Property. Borrower shall not do, nor allow anyone else to do, anything affecting the Property (a) that is in violation of any Environmental Law, (b) which creates an Environmental Condition, or (c) which, due to the presence, use, or release of a Hazardous Substance, creates a condition that adversely affects the value of the Property. The preceding two sentences shall not apply to the presence, use, or storage on the Property of small quantities of Hazardous Substances that are generally recognized to be appropriate to normal residential uses and to maintenance of the Property (including, but not limited to, hazardous substances in consumer products).

Borrower shall promptly give Lender written notice of (a) any investigation, claim, demand, lawsuit or other action by any governmental or regulatory agency or private party involving the Property and any Hazardous Substance or Environmental Law of which Borrower has actual knowledge, (b) any Environmental Condition, including but not limited to, any spilling, leaking, discharge, release or threat of release of any Hazardous Substance, and (c) any condition caused by the presence, use or release of a Hazardous Substance which adversely affects the value of the Property. If Borrower learns, or is notified by any governmental or regulatory authority, or any private party, that any removal or other remediation of any Hazardous Substance affecting the Property is necessary, Borrower shall promptly take all necessary remedial actions in accordance with Environmental Law. Nothing herein shall create any obligation on Lender for an Environmental Cleanup.



NON-UNIFORM COVENANTS. Borrower and Lender further covenant and agree as follows:

22. Acceleration; Remedies. Lender shall give notice to Borrower prior to acceleration following Borrower's breach of any covenant or agreement in this Security Instrument (but not prior to acceleration under Section 18 unless Applicable Law provides otherwise). The notice shall specify: (a) the default; (b) the action required to cure the default; (c) a date, not less than 30 days from the date the notice is given to Borrower, by which the default must be cured; and (d) that failure to cure the default on or before the date specified in the notice may result in acceleration of the sums secured by this Security Instrument and sale of the Property. The notice shall further inform Borrower of the right to reinstate after acceleration and the right to bring a court action to assert the non-existence of a default or any other defense of Borrower to acceleration and sale. If the default is not cured on or before the date specified in the notice, Lender at its option, and without further demand, may invoke the power of sale, including the right to accelerate full payment of the Note, and any other remedies permitted by Applicable Law. Lender shall be entitled to collect all expenses incurred in pursuing the remedies provided in this Section 22, including, but not limited to, reasonable attorneys' fees and costs of title evidence.

If Lender invokes the power of sale, Lender shall execute or cause Trustee to execute written notice of the occurrence of an event of default and of Lender's election to cause the Property to be sold, and shall cause such notice to be recorded in each county in which any part of the Property is located. Lender shall mail copies of the notice as prescribed by Applicable Law to Borrower and to the persons prescribed by Applicable Law. Trustee shall give public notice of sale to the persons and in the manner prescribed by Applicable Law. After the time required by Applicable Law, Trustee, without demand on Borrower, shall sell the Property at public auction to the highest bidder at the time and place and under the terms designated in the notice of sale in one or more parcels and in any order Trustee determines. Trustee may postpone sale of all or any parcel of the Property by public announcement at the time and place of any previously scheduled sale. Lender or its designee may purchase the Property at any sale.

Trustee shall deliver to the purchaser Trustee's deed conveying the Property without any covenant or warranty, expressed or implied. The recitals in the Trustee's deed shall be prima facie evidence of the truth of the statements made therein. Trustee shall apply the proceeds of the sale in the following order: (a) to all expenses of the sale, including, but not limited to, reasonable Trustee's and attorneys' fees; (b) to all sums secured by this Security Instrument; and (c) any excess to the person or persons legally entitled to it.

23. Reconveyance. Upon payment of all sums secured by this Security Instrument, Lender shall request Trustee to reconvey the Property and shall surrender this Security Instrument and all notes evidencing debt secured by this Security Instrument to Trustee. Trustee shall reconvey the Property without warranty to the person or persons legally entitled to it. Such person or persons shall pay any recordation costs. Lender may charge such person or persons a fee for reconveying the Property, but only if the fee is paid to a third party (such as the Trustee) for services rendered and the charging of the fee is permitted under Applicable Law.

24. Substitute Trustee. Lender at its option, may from time to time remove Trustee and appoint a successor trustee to any Trustee appointed hereunder. Without conveyance of the Property, the successor trustee shall succeed to all the title, power and duties conferred upon Trustee herein and by Applicable Law.

25. Assumption Fee. If there is an assumption of this loan, Lender may charge an assumption fee of U.S. \$ one (1%) of the unpaid Principal Balance at the time of Assumption.



BY SIGNING BELOW, Borrower accepts and agrees to the terms and covenants contained in this Security Instrument and in any Rider executed by Borrower and recorded with it.

Witnesses:

CORY J OTTERNESS (Seal)
-Borrower

_____ (Seal)
-Borrower

_____ (Seal)
-Borrower

_____ (Seal)
-Borrower

_____ (Seal)
-Borrower

_____ (Seal)
-Borrower

_____ (Seal)
-Borrower

_____ (Seal)
-Borrower

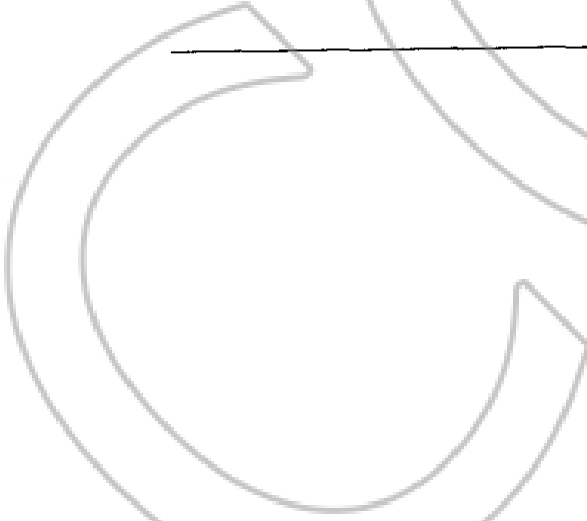

STATE OF ~~NEVADA~~ CALIFORNIA
COUNTY OF SANTA CLARA

This instrument was acknowledged before me on JANUARY 12, 2006 by
CORY J OTTERNESS

T. C. A.

Mail Tax Statements To:
CORY J OTTERNESS
720-A TINA COURT, STATELINE, NV 89449

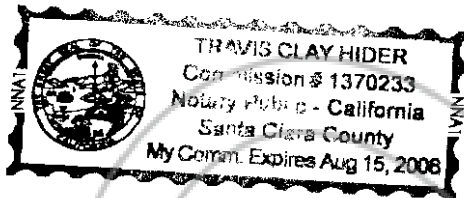

9042077446

VMP-6(NV) (0307).01

Page 15 of 15

Initials: CJO

Form 3029 1/01

EXHIBIT "A"

ALL THAT REAL PROPERTY SITUATED IN THE UNINCORPORATED AREA COUNTY OF DOUGLAS STATE OF NEVADA, BOUNDED AND DESCRIBED AS:

THE LAND REFERRED TO HEREIN IS SITUATED IN THE STATE OF NEVADA, COUNTY OF DOUGLAS, DESCRIBED AS FOLLOWS:

LOT: 403-B, AS SHOWN ON THE AMENDED MAP OF SUMMIT VILLAGE RECORDED IN THE OFFICE OF THE COUNTY RECORDER OF DOUGLAS COUNTY, NEVADA, ON SEPTEMBER 17, 1968, AS DOCUMENT NO, 42231, AND ON SECOND AMENDED MAP RECORDED ON JANUARY 13, 1969, AS DOCUMENT NO. 43419, OFFICIAL RECORDS OF DOUGLAS COUNTY, NEVADA.

FOR INFORMATIONAL PURPOSES ONLY: THE APN IS SHOWN BY THE COUNTY ASSESSOR AS 1319-19-212-055; SOURCE OF TITLE IS BOOK 0804, PAGE 04656 (RECORDED 08/12/04)



RIDER TO PROMISSORY NOTE AND SECURITY INSTRUMENT

Loan Number: 9042077446

Date: January 6, 2006

Property Address: 720-B TINA COURT, STATELINE, NV 89449

This Rider is hereby incorporated into that certain deed of trust/mortgage (Security Instrument), and that certain promissory note (Note), both dated the same date as this Rider executed by Borrower in favor of Downey Savings and Loan Association, F.A. (Lender or Note Holder). Anyone who takes the Note by transfer and who is entitled to receive payments under the Note is also called the Note Holder. All capitalized terms used but not defined in this Rider shall have the same meaning as set forth in the Note and Security Instrument. To the extent that any provisions in this Rider are inconsistent with the Security Instrument and/or the Note, this Rider shall prevail. This Rider is secured by the Security Instrument.

If the Federal Home Loan Mortgage Corporation (FHLMC), the Federal National Mortgage Association (FNMA) or any other investor buys all or some of Lender's rights under the Security Instrument and the Note, the provisions of this Rider, may, at the investor's discretion, no longer have any force or effect. If thereafter FHLMC or FNMA or any other owner should retransfer the Security Instrument and Note to Lender or Lender's successor in interest, then this Rider shall thereupon be automatically reinstated, without any additional writing or document.

1. LATE CHARGES and ACCRUED INTEREST.

If any installment is not received by Note Holder within fifteen (15) days after its due date, Borrower shall pay Note Holder a late charge in an amount equal to ten percent (10.000%) of the installment due that is applicable to the payment of principal and interest, or \$5.00, whichever is greater. If the fifteen day period ends on a weekend or a holiday, the period is extended to the next business day. Borrower acknowledges that it would be difficult and impractical to fix Note Holder's actual damages arising out of any late payment and that the foregoing late payment charge is a reasonable estimate of the same and shall be presumed to be the actual amount. The provisions of this paragraph shall not limit Note Holder's right, under the Security Instrument or otherwise, to compel prompt performance under the Note. Upon default, accrued and unpaid interest shall further bear interest at the then applicable interest rate until paid.

If Borrower is assessed a late charge and sufficient funds are not available in Borrower's checking account when Lender attempts to debit Borrower's loan payment from Borrower's designated checking account, a "returned item charge" will be assessed in addition to the late charge.

2. INTEREST ON PAST DUE SUMS.

If any sum due under the Note is not paid in accordance with the terms of the Note, including accumulated interest, then the sum(s) not paid shall bear interest at the same rate as the principal, or at the maximum rate allowed by law, whichever is less.



3. NOTE HOLDER'S TREATMENT OF PAYMENTS.

Except as otherwise required by law, Note Holder may apply all payments accepted by Note Holder to any outstanding obligations of Borrower under the Loan Documents in any order or priority Note Holder elects in its sole and absolute discretion. Note Holder may disregard any designation or notation by Borrower (or anyone acting on Borrower's behalf) as to how a payment is to be applied by Note Holder. If Note Holder elects not to accept a payment as permitted under Section 1 of the Security Instrument, Note Holder may return the payment to Borrower regardless of who tendered payment, and in such event, Note Holder shall not have any liability to Borrower or any third party as a result thereof. Borrower shall indemnify, defend, protect and hold Note Holder harmless, from and against all claims, damages, expenses, losses and liabilities, in whatever form, suffered or incurred by Note Holder as a result of Note Holder's return of a payment to Borrower.

4. EVENTS OF DEFAULT; REMEDIES.

The following shall constitute additional events of default under the Security Instrument:

- (A) Any person's attempt to reconvey Note Holder's interest in the Property without Note Holder's prior written consent;
- (B) Any person's attempt to have the Note, Security Instrument, this Rider or any of the other Loan Documents declared invalid or unenforceable;
- (C) Failure to pay when due any sum due under any of the Loan Documents;
- (D) Any default under any provision of the Security Instrument; or
- (E) Borrower default under any other deed of trust or other instrument secured by the Property.

Note Holder may use in-house counsel or retain outside lawyers to analyze and respond to any event of default, and Note Holder may charge Borrower reasonable attorneys' fees and costs for such analysis and response. Note Holder may add these legal expenses to the Note and/or demand immediate reimbursement from Borrower. Borrower's failure to promptly reimburse Note Holder shall also constitute an event of default under the Security Instrument.

Upon the occurrence of any events of default, all sums secured by the Security Instrument (including all of Note Holder's attorneys' fees and costs) shall at once become due and payable at the option of Note Holder with or without prior notice by Note Holder and regardless of any prior forbearance. In such event Note Holder, at its option, may then or thereafter deliver to the Trustee a written declaration of default and demand to sell the Property and shall cause to be filed of record a written notice of default and election to cause the Property to be sold. Note Holder shall also deposit with the Trustee the Security Instrument and any notes and all documents evidencing expenditures secured thereby. After the lapse of such time as then may be required by law following recordation of such notice of default, and notice of sale having been given as then required by law, the Trustee, without demand on Borrower, shall sell the Property at the time and place specified by such Trustee in such notice of sale, or at the time to which such noticed sale has been duly postponed, at public auction to the highest bidder for cash in lawful money of the United States, payable at time of sale, except that Note Holder may credit bid at the sale to the extent of the amount owing under the Loan Documents, including the Trustee's fee and expenses. The Trustee may sell the Property as a whole or in separate parcels if there is more than one parcel, subject to such rights as Borrower may have by law to direct the manner or order of sale, or by such other manner of sale which is authorized by law. The Trustee may postpone the sale of all or any portion of the Property by public declaration made by the Trustee at the time and place last appointed for sale. If the Property is sold, the Trustee shall deliver to the purchaser a deed conveying the Property so sold, but without any covenant or warranty, express or implied. The recital in such deed of any matters of fact shall be conclusive proof of the truthfulness thereof.



Any person, including Borrower, the Trustee or Note Holder may purchase at such sale. After deducting all costs, fees and expenses of the Trustee, including costs of evidence of title in connection with such sale, the Trustee shall apply the remaining proceeds of sale first to payment of all sums expended under the terms of the Security Instrument not yet repaid, with accrued interest at the rate then payable under the Note or notes secured thereby, and then to payment of all other sums secured thereby (including the Note). If there be any proceeds remaining, the Trustee shall distribute them to the person or persons legally entitled thereto.

5. HAZARD OR PROPERTY INSURANCE.

Unless Note Holder and Borrower otherwise agree in writing, any insurance proceeds shall be applied first to reimburse Note Holder for costs and expenses incurred in connection with obtaining any such insurance proceeds, and then, at Note Holder's option, in such order and proportion as it may determine in its sole and absolute discretion, and regardless of any impairment of security or lack thereof: (i) to the sums secured by the Security Instrument, whether or not then due, and to such components thereof as Note Holder may determine in its sole and absolute discretion; and/or (ii) to Borrower to pay the costs and expenses of necessary repairs or restoration of the Property to a condition satisfactory to Note Holder. If Borrower abandons the Property, or does not answer within 30 days a notice from Note Holder that the insurance carrier has offered to settle a claim, then Note Holder may collect the insurance proceeds. Note Holder may, in its sole and absolute discretion, and regardless of any impairment of security or lack thereof, use the proceeds to repair or restore the Property or to pay the sums secured by the Security Instrument, whether or not then due. The 30-day period will begin when the notice is given.

If Borrower obtains earthquake insurance, and other hazard insurance, or any other insurance on the Property and such insurance is not specifically required by Note Holder, then (i) Borrower must ensure that such insurance names Note Holder as loss payee and (ii) such insurance shall be subject to this paragraph with respect to use of insurance proceeds.

Note Holder may charge a reasonable fee for the cost of determining whether the building or mobile home securing a loan is located in an area having special flood hazards, subject to applicable law.



9042077446

BY SIGNING BELOW, Borrower accepts and agrees to the terms and covenants contained in this Rider.

CORY J. OTTERNESS

(Seal)
-Borrower

(Seal)
-Borrower

(Seal)
-Borrower

(Seal)
-Borrower

(Seal)
-Borrower

(Seal)
-Borrower

(Seal)
-Borrower

(Seal)
-Borrower



ADJUSTABLE RATE RIDER
(12-Month Treasury Average Index)
(Payment and Rate Caps)

THIS ADJUSTABLE RATE RIDER is made this 6th day of January, 2006, and is incorporated into and shall be deemed to amend and supplement the Mortgage, Deed of Trust or Security Deed (the "Security Instrument") of the same date given by the undersigned (the "Borrower") to secure Borrower's Adjustable Rate Note (the "Note") to **Downey Savings and Loan Association, F.A.**

(the "Lender") of the same date and covering the Property described in the Security Instrument and located at:

720-B TINA COURT, STATELINE, NV 89449

[Property Address]

THE NOTE CONTAINS PROVISIONS THAT WILL CHANGE THE INTEREST RATE AND THE MONTHLY PAYMENT. THERE MAY BE A LIMIT ON THE AMOUNT THAT THE MONTHLY PAYMENT CAN INCREASE OR DECREASE. THE PRINCIPAL AMOUNT TO REPAY COULD BE GREATER THAN THE AMOUNT ORIGINALLY BORROWED, BUT NOT MORE THAN THE LIMIT STATED IN THE NOTE.

ADDITIONAL COVENANTS. In addition to the covenants and agreements made in the Security Instrument, Borrower and Lender further covenant and agree as follows:

A. INTEREST RATE AND MONTHLY PAYMENT CHANGES

The Note provides for changes in the interest rate and the monthly payments, as follows:

2. INTEREST

(A) Interest Rate

Interest will be charged on unpaid Principal until the full amount of Principal has been paid. Until the first day of the calendar month that immediately precedes the first payment date set forth in Section 3(A) below, I will pay interest at a yearly rate of 7.168 %. Thereafter, until the first Interest Change Date (as defined in Section 3(C) below), I will pay interest at a yearly rate of 1.700 %. The interest rate I will pay may change.

The interest rate required by this Section 2 is the rate I will pay both before and after any default described in Section 7(B) of this Note.

9042077446

MULTI STATE ADJUSTABLE RATE RIDER - MTA Index - Single Family

I141R1.UFF (01/12/2001) 7970 VC

Page 1 of 5

Initial: CJO 1/01



0667405 Page: 21 Of 31

BK- 0206
PG- 2011
02/07/2006

(B) Interest Change Dates

The interest rate I will pay may change on the first day of **March**, **2006**, and on that day every month thereafter. Each date on which my interest rate could change is called an "Interest Change Date." The new rate of interest will become effective on each Interest Change Date.

(C) Interest Rate Limit

My interest rate will never be greater than **11.400** %.

(D) Index

Beginning with the first Interest Change Date, my interest rate will be based on an Index. The "Index" is the Twelve-Month Average, determined as set forth below, of the monthly yields ("Monthly Yields") on actively traded United States Treasury Securities adjusted to a constant maturity of one year as published by the Federal Reserve Board in the Federal Reserve Statistical Release entitled "Selected Interest Rates (H.15)." The Twelve-Month Average is determined by adding together the Monthly Yields for the most recent twelve months and dividing by 12.

The most recent Index figure available as of 15 days before each Interest Change Date is called the "Current Index."

If the Index is no longer available, the Note Holder will choose a new Index that is based upon comparable information. The Note Holder will give me notice of this choice.

(E) Calculation of Interest Rate Changes

Before each Interest Change Date, the Note Holder will calculate my new interest rate by adding **three and fifty-five hundredth(s)** percentage point(s)

3.550 % to the Current Index. Subject to the limit stated in Section 2(C) above, the result of this addition will be my new interest rate until the next Interest Change Date.

3. PAYMENTS

(A) Time and Place of Payments

I will pay Principal and interest by making a payment every month.

I will make my monthly payments on the first day of each month beginning on

March 1, **2006**. I will make these payments every month until I have paid all the Principal and interest and any other charges described below that I may owe under this Note. My monthly payments will be applied to interest before Principal. If, on **February 1, 2046**, I still owe amounts under this Note, I will pay these amounts in full on that date, which is called the "Maturity Date."

I will make my monthly payments at **P.O. Box 6060, 3501 Jamboree Rd, Newport Beach, CA 92658-6060**

or at a different place if required by the Note Holder.

(B) Amount of My Initial Monthly Payments

Each of my initial monthly payments will be U.S. \$ **479.75**. This amount may change.

(C) Payment Change Dates

My monthly payment may change as required by Section 3(D) below beginning on the first day of **March**, **2007**, and on that day every 12th month thereafter. Each of these

9042077446

CJO

dates is called a "Payment Change Date." My monthly payment also will change at any time Section 3(F) or 3(G) below requires me to pay a different monthly payment.

I will pay the amount of my new monthly payment each month beginning on each Payment Change Date or as provided in Section 3(F) or 3(G) below.

(D) Calculation of Monthly Payment Changes

Before each Payment Change Date, the Note Holder will calculate the amount of the monthly payment that would be sufficient to repay the unpaid Principal that I am expected to owe at the Payment Change Date in full on the Maturity Date in substantially equal installments at the interest rate effective during the month preceding the Payment Change Date. The result of this calculation is called the "Full Payment." Unless Section 3(F) or 3(G) below requires me to pay a different amount, my new monthly payment will be in the amount of the Full Payment, except that my new monthly payment will be limited to an amount that will not be more than 7.5% greater or less than the amount of my last monthly payment due before the Payment Change Date.

(E) Additions to My Unpaid Principal

My monthly payment could be less than the amount of the interest portion of the monthly payment that would be sufficient to repay the unpaid Principal I owe at the monthly payment date in full on the Maturity Date in substantially equal payments. If so, each month that my monthly payment is less than the interest portion, the Note Holder will subtract the amount of my monthly payment from the amount of the interest portion and will add the difference to my unpaid Principal. The Note Holder also will add interest on the amount of this difference to my unpaid Principal each month. The interest rate on the interest added to Principal will be the rate required by Section 2 above.

(F) Limit on My Unpaid Principal; Increased Monthly Payment

My unpaid Principal can never exceed a maximum amount equal to one hundred **ten** percent (**110** %)

of the Principal amount I originally borrowed. My unpaid Principal could exceed that maximum amount due to the limited payments and interest rate increases. If so, on the date that my paying my monthly payment would cause me to exceed that limit, I will instead pay a new monthly payment. The new monthly payment will be in an amount that would be sufficient to repay my then unpaid Principal in full on the Maturity Date at my current interest rate in substantially equal payments.

(G) Required Full Payment

On the 5th Payment Change Date and on each succeeding 5th Payment Change Date thereafter, I will begin paying the Full Payment as my monthly payment until my monthly payment changes again. I also will begin paying the Full Payment as my monthly payment on the final Payment Change Date.

4. NOTICE OF CHANGES

The Note Holder will deliver or mail to me a notice of any changes in the amount of my monthly payment before the effective date of any change. The notice will include information required by law to be

9042077446

1141R3.UFF (01/12/2001) 7970 VC

Page 3 of 5

Initials: 

1/01



BK- 0206
PG- 2013
0667405 Page: 23 of 31 02/07/2006

given me and also the title and telephone number of a person who will answer any question I may have regarding the notice.

B. TRANSFER OF THE PROPERTY OR A BENEFICIAL INTEREST IN BORROWER

Uniform Covenant 18 of the Security Instrument is amended to read as follows:

Transfer of the Property or a Beneficial Interest in Borrower. As used in this Section 18, "Interest in the Property" means any legal or beneficial interest in the Property, including, but not limited to, those beneficial interests transferred in a bond for deed, contract for deed, installment sales contract or escrow agreement, the intent of which is the transfer of title by Borrower at a future date to a purchaser.

If all or any part of the Property or any interest in the Property is sold or transferred (or if Borrower is not a natural person and a beneficial interest in Borrower is sold or transferred) without Lender's prior written consent, Lender may require immediate payment in full of all sums secured by this Security Instrument. However, this option shall not be exercised by Lender if exercise is prohibited by Applicable Law. Lender also shall not exercise this option if: (a) Borrower causes to be submitted to Lender information required by Lender to evaluate the intended transferee as if a new loan were being made to the transferee; and (b) Lender reasonably determines that Lender's security will not be impaired by the loan assumption and that the risk of a breach of any covenant or agreement in this Security Instrument is acceptable to Lender.

To the extent permitted by Applicable Law, Lender may charge a reasonable fee as a condition to Lender's consent to the loan assumption. Lender may also require the transferee to sign an assumption agreement that is acceptable to Lender and that obligates the transferee to keep all the promises and agreements made in the Note and in this Security Instrument. Borrower will continue to be obligated under the Note and this Security Instrument unless Lender releases Borrower in writing.

If Lender exercises the option to require immediate payment in full, Lender shall give Borrower notice of acceleration. The notice shall provide a period of not less than 30 days from the date the notice is delivered or mailed within which Borrower must pay all sums secured by this Security Instrument. If Borrower fails to pay these sums prior to the expiration of this period, Lender may invoke any remedies permitted by this Security Instrument without further notice or demand on Borrower.

9042077446

1141R4.UFF (01/12/2001) 7970 VC

Page 4 of 5

Initials

gjo

1/01



0667405

Page: 24 Of 31

BK- 0206
PG- 2014
02/07/2006

BY SIGNING BELOW, Borrower accepts and agrees to the terms and covenants contained in this Adjustable Rate Rider.



CORY J OTTERNESS (Seal)
-Borrower

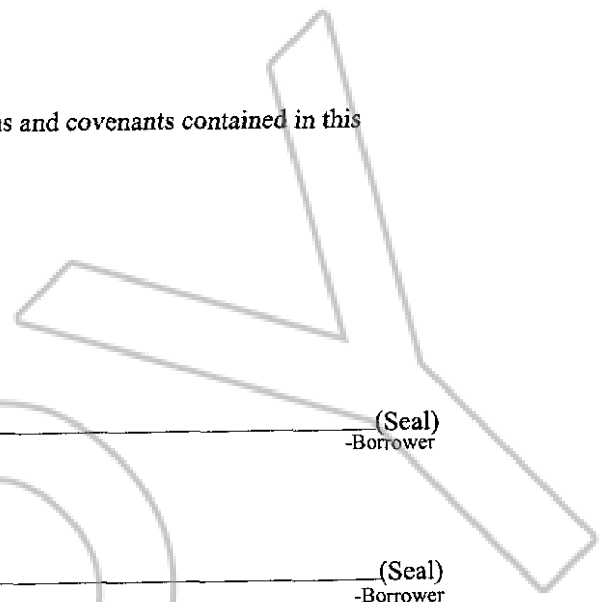

(Seal)
-Borrower

(Seal)
-Borrower

(Seal)
-Borrower

(Seal)
-Borrower

(Seal)
-Borrower

(Seal)
-Borrower

[Sign Original Only]

9042077446

1141R5.UFF (05/09/03) CR-2054 VC

Page 5 of 5

Initials  1/01

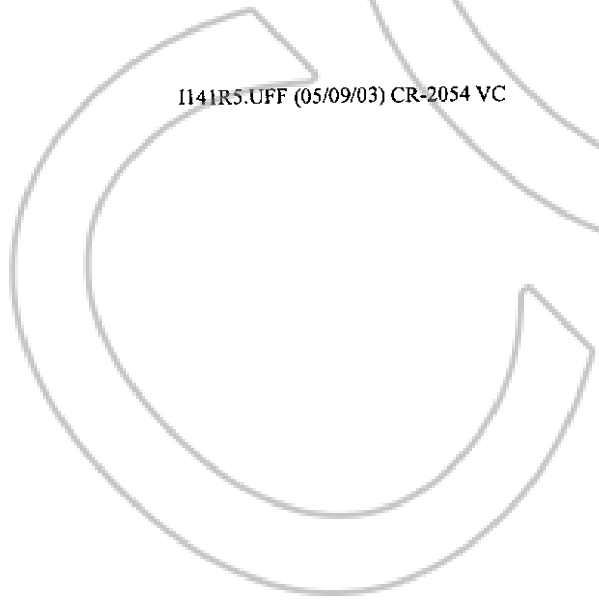

PLANNED UNIT DEVELOPMENT RIDER

THIS PLANNED UNIT DEVELOPMENT RIDER is made this **6th** day of **January, 2006**, and is incorporated into and shall be deemed to amend and supplement the Mortgage, Deed of Trust, or Security Deed (the "Security Instrument") of the same date, given by the undersigned (the "Borrower") to secure Borrower's Note to **Downey Savings and Loan Association, F.A.**

(the "Lender") of the same date and covering the Property described in the Security Instrument and located at: **720-B TINA COURT, STATELINE, NV 89449**

[Property Address]

The Property includes, but is not limited to, a parcel of land improved with a dwelling, together with other such parcels and certain common areas and facilities, as described in **Covenants, Conditions, and Restrictions**

(the "Declaration"). The Property is a part of a planned unit development known as **SUMMIT VILLAGE**

[Name of Planned Unit Development]

(the "PUD"). The Property also includes Borrower's interest in the homeowners association or equivalent entity owning or managing the common areas and facilities of the PUD (the "Owners Association") and the uses, benefits and proceeds of Borrower's interest.

PUD COVENANTS. In addition to the covenants and agreements made in the Security Instrument, Borrower and Lender further covenant and agree as follows:

A. PUD Obligations. Borrower shall perform all of Borrower's obligations under the PUD's Constituent Documents. The "Constituent Documents" are the (i) Declaration; (ii) articles of incorporation, trust instrument or any equivalent document which creates the Owners Association; and (iii) any by-laws or other rules or regulations of the Owners Association. Borrower shall promptly pay, when due, all dues and assessments imposed pursuant to the Constituent Documents.

9042077446

MULTISTATE PUD RIDER - Single Family - Fannie Mae/Freddie Mac UNIFORM INSTRUMENT Form 3150 1/01

Page 1 of 3

Initials: 

 -7R (0411)

VMP Mortgage Solutions, Inc. (800)521-7291



0667405

Page: 26 of 31

BK- 0206
PG- 2016
02/07/2006

B. Property Insurance. So long as the Owners Association maintains, with a generally accepted insurance carrier, a "master" or "blanket" policy insuring the Property which is satisfactory to Lender and which provides insurance coverage in the amounts (including deductible levels), for the periods, and against loss by fire, hazards included within the term "extended coverage," and any other hazards, including, but not limited to, earthquakes and floods, for which Lender requires insurance, then: (i) Lender waives the provision in Section 3 for the Periodic Payment to Lender of the yearly premium installments for property insurance on the Property; and (ii) Borrower's obligation under Section 5 to maintain property insurance coverage on the Property is deemed satisfied to the extent that the required coverage is provided by the Owners Association policy.

What Lender requires as a condition of this waiver can change during the term of the loan.

Borrower shall give Lender prompt notice of any lapse in required property insurance coverage provided by the master or blanket policy.

In the event of a distribution of property insurance proceeds in lieu of restoration or repair following a loss to the Property, or to common areas and facilities of the PUD, any proceeds payable to Borrower are hereby assigned and shall be paid to Lender. Lender shall apply the proceeds to the sums secured by the Security Instrument, whether or not then due, with the excess, if any, paid to Borrower.

C. Public Liability Insurance. Borrower shall take such actions as may be reasonable to insure that the Owners Association maintains a public liability insurance policy acceptable in form, amount, and extent of coverage to Lender.

D. Condemnation. The proceeds of any award or claim for damages, direct or consequential, payable to Borrower in connection with any condemnation or other taking of all or any part of the Property or the common areas and facilities of the PUD, or for any conveyance in lieu of condemnation, are hereby assigned and shall be paid to Lender. Such proceeds shall be applied by Lender to the sums secured by the Security Instrument as provided in Section 11.

E. Lender's Prior Consent. Borrower shall not, except after notice to Lender and with Lender's prior written consent, either partition or subdivide the Property or consent to: (i) the abandonment or termination of the PUD, except for abandonment or termination required by law in the case of substantial destruction by fire or other casualty or in the case of a taking by condemnation or eminent domain; (ii) any amendment to any provision of the "Constituent Documents" if the provision is for the express benefit of Lender; (iii) termination of professional management and assumption of self-management of the Owners Association; or (iv) any action which would have the effect of rendering the public liability insurance coverage maintained by the Owners Association unacceptable to Lender.

F. Remedies. If Borrower does not pay PUD dues and assessments when due, then Lender may pay them. Any amounts disbursed by Lender under this paragraph F shall become additional debt of Borrower secured by the Security Instrument. Unless Borrower and Lender agree to other terms of payment, these amounts shall bear interest from the date of disbursement at the Note rate and shall be payable, with interest, upon notice from Lender to Borrower requesting payment.



BY SIGNING BELOW, Borrower accepts and agrees to the terms and covenants contained in this PUD Rider.

CORY J OTTERNESS

____ (Seal)
-Borrower

____ (Seal)
-Borrower

____ (Seal)
-Borrower

____ (Seal)
-Borrower

____ (Seal)
-Borrower

____ (Seal)
-Borrower

____ (Seal)
-Borrower

____ (Seal)
-Borrower

VMP[®]-7R (0411)

Page 3 of 3

9042077446

Form 3150 1/01



BK- 0206
PG- 2018
0667405 Page: 28 Of 31 02/07/2006

1-4 FAMILY RIDER (Assignment of Rents)

THIS 1-4 FAMILY RIDER is made this 6th day of January, 2006, and is incorporated into and shall be deemed to amend and supplement the Mortgage, Deed of Trust, or Security Deed (the "Security Instrument") of the same date given by the undersigned (the "Borrower") to secure Borrower's Note to Downey Savings and Loan Association, F.A.

(the "Lender") of the same date and covering the Property described in the Security Instrument and located at: 720-B TINA COURT, STATELINE, NV 89449

[Property Address]

1-4 FAMILY COVENANTS. In addition to the covenants and agreements made in the Security Instrument, Borrower and Lender further covenant and agree as follows:

A. ADDITIONAL PROPERTY SUBJECT TO THE SECURITY INSTRUMENT. In addition to the Property described in the Security Instrument, the following items now or hereafter attached to the Property to the extent they are fixtures are added to the Property description, and shall also constitute the Property covered by the Security Instrument: building materials, appliances and goods of every nature whatsoever now or hereafter located in, on, or used, or intended to be used in connection with the Property, including, but not limited to, those for the purposes of supplying or distributing heating, cooling, electricity, gas, water, air and light, fire prevention and extinguishing apparatus, security and access control apparatus, plumbing, bath tubs, water heaters, water closets, sinks, ranges, stoves, refrigerators, dishwashers, disposals, washers, dryers, awnings, storm windows, storm doors, screens, blinds, shades, curtains and curtain rods, attached mirrors, cabinets, paneling and attached floor coverings, all of which, including replacements and additions thereto, shall be deemed to be and remain a part of the Property covered by the Security Instrument. All of the foregoing together with the Property described in the Security Instrument (or the leasehold estate if the Security Instrument is on a leasehold) are referred to in this 1-4 Family Rider and the Security Instrument as the "Property."

B. USE OF PROPERTY; COMPLIANCE WITH LAW. Borrower shall not seek, agree to or make a change in the use of the Property or its zoning classification, unless Lender has agreed in writing to the change. Borrower shall comply with all laws, ordinances, regulations and requirements of any governmental body applicable to the Property.

C. SUBORDINATE LIENS. Except as permitted by federal law, Borrower shall not allow any lien inferior to the Security Instrument to be perfected against the Property without Lender's prior written permission.

D. RENT LOSS INSURANCE. Borrower shall maintain insurance against rent loss in addition to the other hazards for which insurance is required by Section 5.

9042077446

MULTISTATE 1-4 FAMILY RIDER - Fannie Mae/Freddie Mac UNIFORM INSTRUMENT
Form 3170 1/01

VMP-57R (0411)

Page 1 of 3

Initials: *gio*

VMP Mortgage Solutions, Inc.
(800)521-7291



0667405

Page: 29 Of 31

BK- 0206
PG- 2019
02/07/2006

E. "BORROWER'S RIGHT TO REINSTATE" DELETED. Section 19 is deleted.

F. BORROWER'S OCCUPANCY. Unless Lender and Borrower otherwise agree in writing, Section 6 concerning Borrower's occupancy of the Property is deleted.

G. ASSIGNMENT OF LEASES. Upon Lender's request after default, Borrower shall assign to Lender all leases of the Property and all security deposits made in connection with leases of the Property. Upon the assignment, Lender shall have the right to modify, extend or terminate the existing leases and to execute new leases, in Lender's sole discretion. As used in this paragraph G, the word "lease" shall mean "sublease" if the Security Instrument is on a leasehold.

H. ASSIGNMENT OF RENTS; APPOINTMENT OF RECEIVER; LENDER IN POSSESSION. Borrower absolutely and unconditionally assigns and transfers to Lender all the rents and revenues ("Rents") of the Property, regardless of to whom the Rents of the Property are payable. Borrower authorizes Lender or Lender's agents to collect the Rents, and agrees that each tenant of the Property shall pay the Rents to Lender or Lender's agents. However, Borrower shall receive the Rents until: (i) Lender has given Borrower notice of default pursuant to Section 22 of the Security Instrument, and (ii) Lender has given notice to the tenant(s) that the Rents are to be paid to Lender or Lender's agent. This assignment of Rents constitutes an absolute assignment and not an assignment for additional security only.

If Lender gives notice of default to Borrower: (i) all Rents received by Borrower shall be held by Borrower as trustee for the benefit of Lender only, to be applied to the sums secured by the Security Instrument; (ii) Lender shall be entitled to collect and receive all of the Rents of the Property; (iii) Borrower agrees that each tenant of the Property shall pay all Rents due and unpaid to Lender or Lender's agents upon Lender's written demand to the tenant; (iv) unless applicable law provides otherwise, all Rents collected by Lender or Lender's agents shall be applied first to the costs of taking control of and managing the Property and collecting the Rents, including, but not limited to, attorney's fees, receiver's fees, premiums on receiver's bonds, repair and maintenance costs, insurance premiums, taxes, assessments and other charges on the Property, and then to the sums secured by the Security Instrument; (v) Lender, Lender's agents or any judicially appointed receiver shall be liable to account for only those Rents actually received; and (vi) Lender shall be entitled to have a receiver appointed to take possession of and manage the Property and collect the Rents and profits derived from the Property without any showing as to the inadequacy of the Property as security.

If the Rents of the Property are not sufficient to cover the costs of taking control of and managing the Property and of collecting the Rents any funds expended by Lender for such purposes shall become indebtedness of Borrower to Lender secured by the Security Instrument pursuant to Section 9.

Borrower represents and warrants that Borrower has not executed any prior assignment of the Rents and has not performed, and will not perform, any act that would prevent Lender from exercising its rights under this paragraph.

Lender, or Lender's agents or a judicially appointed receiver, shall not be required to enter upon, take control of or maintain the Property before or after giving notice of default to Borrower. However, Lender, or Lender's agents or a judicially appointed receiver, may do so at any time when a default occurs. Any application of Rents shall not cure or waive any default or invalidate any other right or remedy of Lender. This assignment of Rents of the Property shall terminate when all the sums secured by the Security Instrument are paid in full.

I. CROSS-DEFAULT PROVISION. Borrower's default or breach under any note or agreement in which Lender has an interest shall be a breach under the Security Instrument and Lender may invoke any of the remedies permitted by the Security Instrument.

9042077446

Initials: *JO*
Form 3170 1/01

VMP-57R (0411)

Page 2 of 3



BK- 0206
PG- 2020
0667405 Page: 30 Of 31 02/07/2006

BY SIGNING BELOW, Borrower accepts and agrees to the terms and covenants contained in this 1-4 Family Rider.

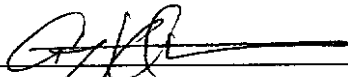

CORY J. OTTERNESS (Seal)
-Borrower

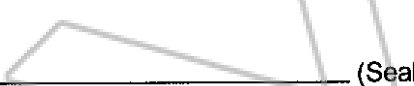

(Seal)
-Borrower

(Seal)
-Borrower

(Seal)
-Borrower

(Seal)
-Borrower

(Seal)
-Borrower

(Seal)
-Borrower

(Seal)
-Borrower

-57R (0411)

Page 3 of 3

9042077446
Form 3170 1/01